

2016



Chevrolet MyLink Infotainment System



chevrolet.com (U.S.)
chevrolet.gm.ca (Canada)

Contents

Introduction	2
Radio	17
Audio Players	27
OnStar System	35
Rear Seat Infotainment	36
Navigation	54
Voice Recognition	80
Phone	87
Settings	95
Trademarks and License Agreements	98
Index	109

Introduction



The names, logos, emblems, slogans, vehicle model names, and vehicle body designs appearing in this manual including, but not limited to, GM, the GM logo, CHEVROLET, the CHEVROLET Emblem, and the names Silverado, Colorado, Tahoe, Suburban, Camaro, Cruze, Malibu, Impala, Volt, and MyLink are registered trademarks of General Motors Corporation LLC.

The information in this manual supplements the owner manual. This manual includes the latest

information available at the time it was printed. We reserve the right to make changes in the product after that time without notice. For vehicles first sold in Canada, substitute the name General Motors of Canada Limited for Chevrolet Motor Division whenever it appears in this manual.

This manual describes features that may or may not be on the vehicle because of optional equipment that was not purchased on the vehicle, model variants, country specifications, features/applications that may not be available in your region, or changes subsequent to the printing of this manual.

Keep this manual with the owner manual in the vehicle, so it will be there if it is needed. If the vehicle is sold, leave this manual in the vehicle.

Overview

Read the following pages to become familiar with the infotainment system features.

Warning

Taking your eyes off the road for too long or too often while using any infotainment feature can cause a crash. You or others could be injured or killed. Do not give extended attention to infotainment tasks while driving. Limit your glances at the vehicle displays and focus your attention on driving. Use voice commands whenever possible.

The infotainment system has built-in features intended to help avoid distraction by disabling some functions when driving. These functions may gray out when they are unavailable. Many infotainment

features are also available through the instrument cluster and steering wheel controls.

Before driving:

- Become familiar with the operation, faceplate buttons, and screen buttons.
- Set up the audio by presetting favorite stations, setting the tone, and adjusting the speakers.
- Set up phone numbers in advance so they can be called easily by pressing a single button or by using a single voice command if equipped with Bluetooth phone capability.

See “Defensive Driving” in the owner manual.







To play the infotainment system with the ignition off, see “Retained Accessory Power (RAP)” in the owner manual.

Infotainment System



The infotainment system is controlled by using the touchscreen, the buttons below the touchscreen, steering wheel controls, and voice recognition.



Radios with Screen Storage

- | | |
|---|--|
| 1.  (Power) | 6.  (Eject) |
| 2. MEDIA | 7.  (Home Page) |
| 3. RADIO | 8.  BACK |
| 4.  | 9. CD Slot |
| 5.  (Screen) | 10. MENU |

4 Introduction

If equipped with storage behind the radio, press  and hold to open. There is a USB port inside. Press  and hold again to close. Keep the storage area closed when not in use. See the owner manual.

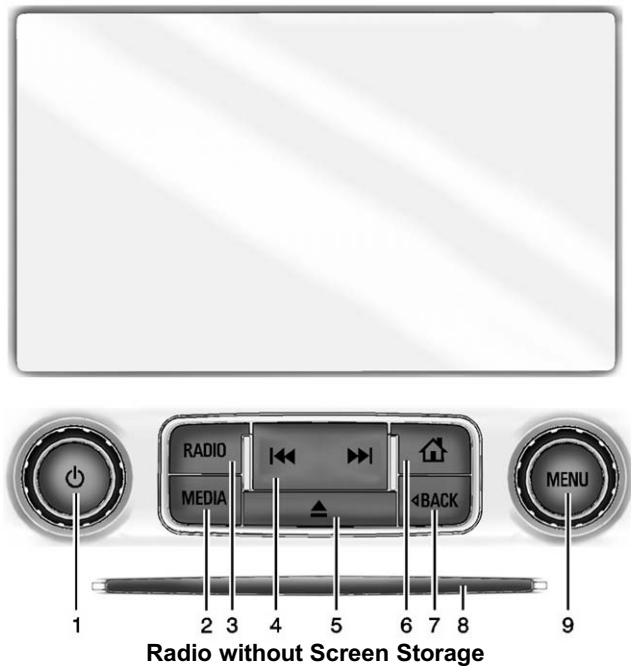

1.  (Power)
2. MEDIA

3. RADIO
4.  or 

5. ▲ (Eject)
6. 🏠 (Home Page)
7. ◀ BACK
8. CD Slot
9. MENU



Radio with TONE

This radio is the same as above except TONE replaces the ▲ (eject) button.

6 Introduction

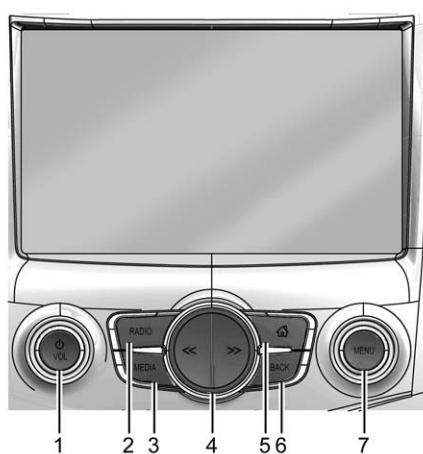

Cruze

- | | |
|-------------------------|------------|
| 1. /VOL (Power/Volume) | 5. (Home) |
| 2. RADIO | 6. BACK |
| 3. MEDIA | 7. MENU |
| 4. or (Previous/Next) | |

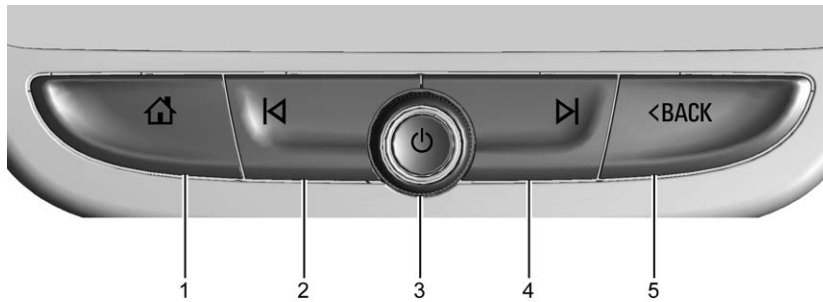
**Camaro, Malibu, Volt**

1. 🏠 (Home Page)
2. ⏮
3. ⏻ (Power)
4. ⏭
5. ⏪ <BACK

8 Introduction

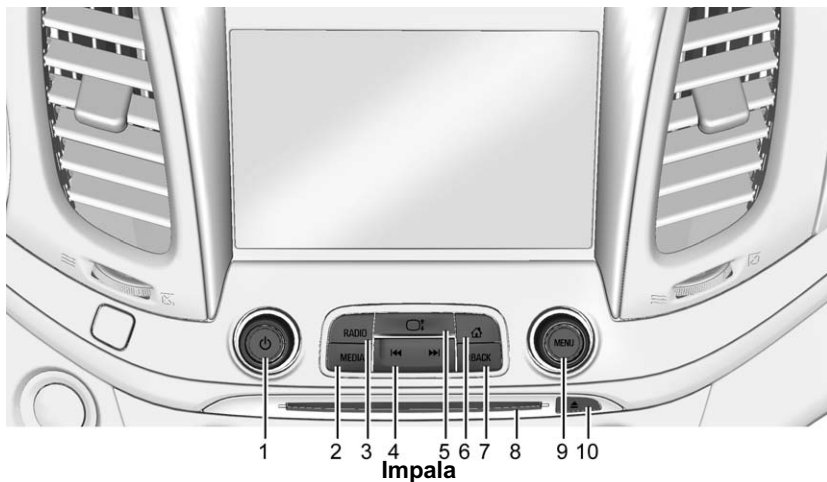

1. (Power)
2. MEDIA
3. RADIO
4. or
5. (Screen)

6. (Home Page)
7. BACK
8. CD Slot
9. MENU
10. (Eject)

Power (On/Off/Mute)

- When off, press to turn the system on. Press and hold to turn off.
- When on, press to mute the system. Press again to unmute the system.

Volume

Turn to increase or decrease the volume.

Home Page

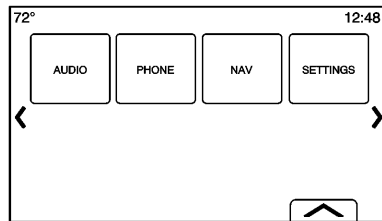

The Home Page is where vehicle application icons are accessed. Some applications are disabled when the vehicle is moving.

The Home Page can be set up to have up to five pages with eight icons per page.

Touch ‹ or › to access the pages of icons.

‹ **(Previous)** : Touch to go to the previous Home Page.

› **(Next)** : Touch to go to the next Home Page.

⤴ **(Interaction Selector)** : Touch to display the favorites list.

Touch and hold a location within the favorites area to begin the process of saving a favorite application.

Touch the application icon to store as a favorite. The name of the application will be shown in favorites.

Managing Home Page Icons

1. Touch and hold any of the Home Page icons to enter edit mode.
2. Continue holding the icon and drag it to the desired position.
3. Release your finger to drop the icon in the desired position.
4. To move an application to another page, drag the icon to the edge of the screen toward the desired page.
5. Continue dragging and dropping application icons as desired.
6. Press ⤴ to exit edit mode.

Steering Wheel Controls (Silverado, Tahoe, Suburban, and Colorado)







Silverado, Tahoe, Suburban Shown, Colorado Similar

If equipped, some audio controls can be adjusted at the steering wheel.

⤴ **(Talk)** : For vehicles with OnStar® or a Bluetooth® system, press to interact with those systems. See “OnStar Overview” in the owner manual, *Bluetooth (Overview)* ⇨ 87 or *Bluetooth (Infotainment Controls)* ⇨ 88 or *Bluetooth (Voice Recognition)* ⇨ 91.

 **(Phone/Mute)** : Press to decline an incoming call, or end a current call. Press to mute or unmute the infotainment system when not on a call.

 or  **(Previous/Next Menu)** : Press to go to the previous or next menu option.

 or  **(Next/Previous Selection)** : Press to go to the next or previous selection.

 **(Select)** : Press to select a highlighted menu option.

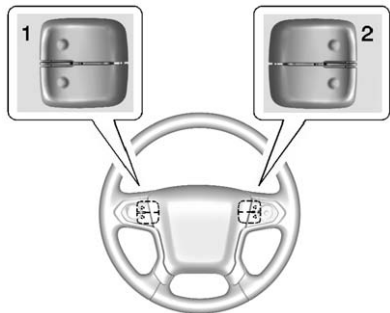



The favorites and volume switches are on the back of the steering wheel.

1. **Favorite:** When on a radio source, press to select the next or previous audio broadcast favorite. When listening to a media device, press to select the next or previous track.
2. **Volume:** Press to increase or decrease the volume.







Colorado Steering Wheel Controls

 **(Talk)** : For vehicles with OnStar[®] or a Bluetooth[®] system, press to interact with those systems. See “OnStar Overview” in the owner manual, *Bluetooth (Overview)* ⇨ 87 or *Bluetooth (Infotainment Controls)* ⇨ 88 or *Bluetooth (Voice Recognition)* ⇨ 91.

 **(Phone/Mute)** : Press to decline an incoming call, or end a current call. Press to mute or unmute the infotainment system when not on a call.

SRC (Source) : Press to change the source.

 or  **(Previous/Next Menu)** : Press to go to the previous or next menu option.

+  or  - (Volume) : Press to increase or decrease the volume.

Steering Wheel Controls (Impala, Cruze, and Malibu)



Impala Shown, Cruze and Malibu Similar

If equipped, some audio controls can be adjusted at the steering wheel.

☎ (Talk) : Press to answer an incoming call or to start a voice recognition session. See *Bluetooth (Overview)* ⇨ 87 or *Bluetooth (Infotainment Controls)* ⇨ 88 or *Bluetooth (Voice Recognition)* ⇨ 91 or “OnStar Overview” in the owner manual.

☎ (Phone/Mute) : Press to decline an incoming call, or end a current call. Press to mute or unmute the infotainment system when not on a call.

◀ or ▶ (Previous/Next Menu) : Press to go to the previous or next area in the display or back in a list.

△ or ▽ (Next/Previous Selection) : Press to change radio stations in audio mode, change Info Pages, or go up or down in a list.

✓ (Select) : Press to select a highlighted menu option.

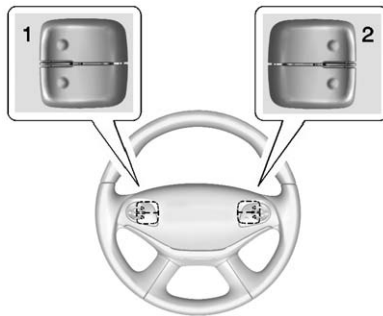

The favorite and volume switches are on the back of the steering wheel.

1. Favorites: Press to select the next or previous favorite radio station. While playing media, press to select the next or previous track or song.
2. Volume: Press to increase or decrease the volume.

Steering Wheel Controls (Camaro)

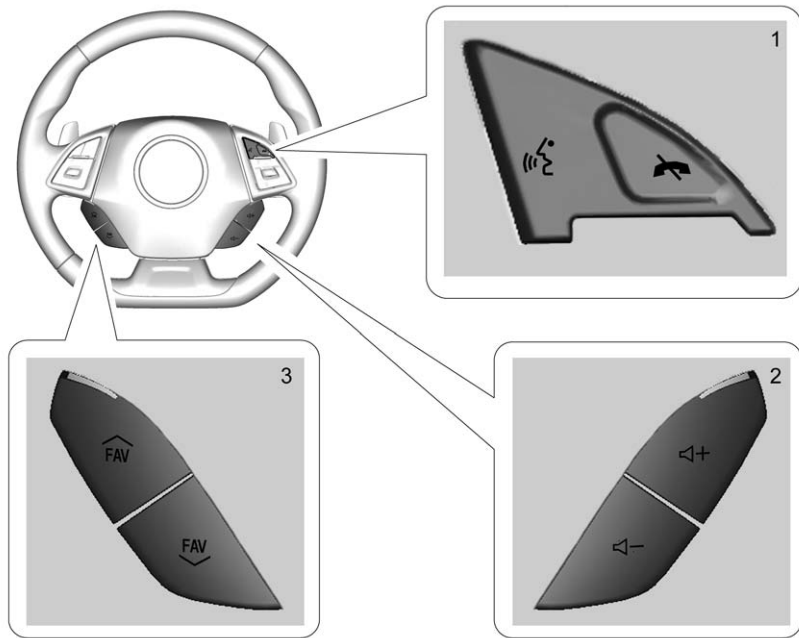

If equipped, some audio controls can be adjusted at the steering wheel.

🔊 (1) (Push to Talk) : Press to answer an incoming call or to start a voice recognition session. See *Bluetooth (Overview)* ⇨ 87 or *Bluetooth (Infotainment Controls)* ⇨ 88 or *Bluetooth (Voice Recognition)* ⇨ 91 or “OnStar Overview” in the owner manual.

🔇 (1) (Phone/Mute) : Press to decline an incoming call, or end a current call. Press to mute or unmute the infotainment system when not on a call.

🔊 + or 🔊 - (2) (Volume) : Press to increase or decrease volume.

⤴ FAV or FAV ⤵ (3) (Next or Previous Favorite) : Press to display a list of favorites. Press again to select the next or previous favorite when listening to the radio.

Steering Wheel Controls (Vot)

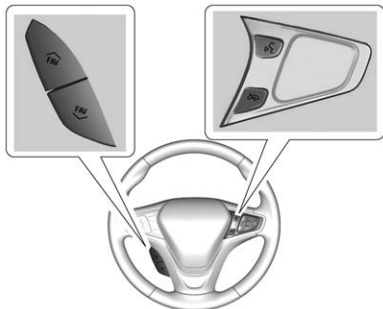

If equipped, some audio controls can be adjusted at the steering wheel.

☎ (Talk) : Press to answer an incoming call or to start a voice recognition session. See *Bluetooth (Overview)* ⇨ 87 or *Bluetooth (Infotainment Controls)* ⇨ 88 or *Bluetooth (Voice Recognition)* ⇨ 91 or “OnStar Overview” in the owner manual.

☎ (Phone/Mute) : Press to decline an incoming call, or end a current call. Press to mute or unmute the infotainment system when not on a call.

⤴ FAV or FAV ⤵ (Next or Previous Favorite) : Press to display a list of favorites. Press again to select the next or previous favorite when listening to the radio.

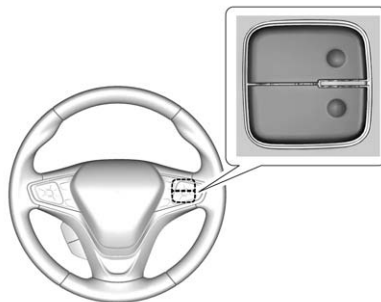

The volume switches are on the back of the steering wheel. Press to increase or decrease the volume.

Using the System

Touchscreen Buttons

Touchscreen buttons show on the screen when available. When a function is unavailable, the button may gray out. When a function is selected, the button may highlight.

Home Page Features

Touch the icons on the Home Page screen to launch an application.

Audio

Touch the AUDIO icon to display the active audio source page. Available sources are AM, FM, XM (if equipped), CD (if equipped), My Media, USB, SD, Bluetooth, and AUX Input.

Phone

Touch the PHONE icon to display the Phone main page. See *Bluetooth (Overview)* ⇨ 87 or *Bluetooth (Infotainment Controls)* ⇨ 88 or *Bluetooth (Voice Recognition)* ⇨ 91.

NAV/ OnStar Nav (Navigation, If Equipped)

Touch the NAV icon to display the navigation map or OnStar Turn-by-Turn Navigation. See *Using the Navigation System* ⇨ 54 or “OnStar Navigation” in the owner manual.

Settings

Touch the SETTINGS icon to display the Settings menu. See *Settings* ⇨ 95.

Pandora (If Equipped)

Touch the PANDORA icon to begin Pandora®. See *Pandora Internet Radio* ⇨ 23.

Weather (If Equipped)

Touch the WEATHER icon to display the Weather main page. See “SiriusXM Travel Link Weather (If Equipped)” under *Destination* ⇨ 62.

OnStar (If Equipped)

Touch the ONSTAR icon to display the OnStar main page and start OnStar voice recognition. See “OnStar Overview” in the owner manual.

Video (If Equipped)

Touch the VIDEO icon to display the video Rear Seat Entertainment main page. See *Rear Seat Entertainment (RSE) System* ⇨ 36.

Applications Tray



The applications tray is at the top-center of the screen. The applications tray can have three to five applications.

To add an application from the Home Page to the applications tray:

1. Touch and hold any icon on the Home Page to enter edit mode.

2. Drag the icon to the applications tray.

To remove an item from the applications tray, drag the icon from the applications tray back to the Home Page.

Press  to exit edit mode.

Adding or removing applications from the applications tray will not remove them from the Home Page.

Infotainment Gestures

Use the following finger gestures to control the infotainment system.

Touch/Tap

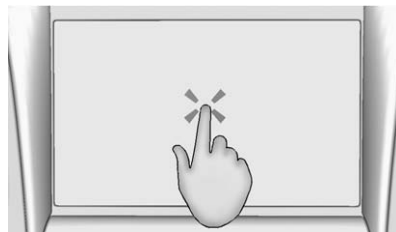

Touch/tap is used to select a button or option, activate an application, or change the location inside a map.

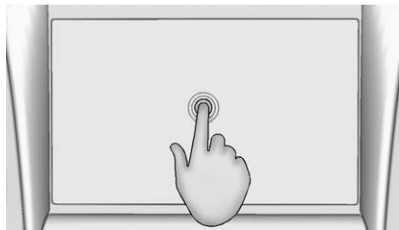
Touch and Hold

Touch and hold can be used to start another gesture, move, or delete an application.

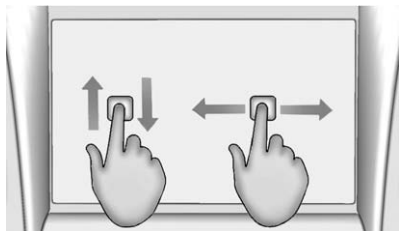
Drag

Drag is used to move applications on the Home Page, or to pan the map. To drag the item, it must be

held and moved along the screen to the new location. This can be done up, down, right, or left.

Nudge

Nudge is used to move items a short distance on a list or a map. To nudge, hold and quickly move the selected item up or down to a new location.

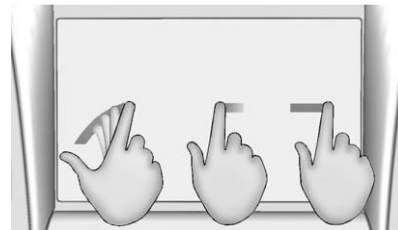
Fling or Swipe

Fling or swipe is used to scroll through a list, pan the map, or change page views. Do this by placing a finger on the screen then moving it rapidly up and down or right and left.

Turn

Turn the MENU knob or \odot knob on the faceplate to perform functions such as tuning the radio or scrolling lists.

Cleaning High Gloss Surfaces and Vehicle Information and Radio Displays

For vehicles with high gloss surfaces or vehicle displays, use a microfiber cloth to wipe surfaces.

Before wiping the surface with the microfiber cloth, use a soft bristle brush to remove dirt that could scratch the surface. Then use the microfiber cloth by gently rubbing to clean. Never use window cleaners or solvents. Periodically hand wash the microfiber cloth separately, using mild soap. Do not use bleach or fabric softener. Rinse thoroughly and air dry before next use.

Software Updates

Website Information

In the U.S., see www.chevrolet.com

In Canada, see
www.chevrolet.gm.ca

Radio

AM-FM Radio

Playing the Radio

While on the Audio main page the available sources are: AM, FM, XM (if equipped), CD (if equipped), My Media, USB, SD, Bluetooth, and AUX Input.

- Press the RADIO button on the faceplate or touch the Audio screen button on the Home Page to scroll through AM, FM, or SiriusXM (if equipped).
- Press the MEDIA button on the faceplate or touch the Audio screen button on the Home Page to scroll through CD (if equipped), My Media USB, SD, Bluetooth, and AUX Input.

Infotainment System Settings

Press the RADIO button to access broadcast sources.

Touch the MENU screen button or the MENU knob to display the following menus:

Tone Settings:

- Bass, Midrange, Treble, Surround (if equipped): Touch + or - to adjust. Surround adjusts the headrest speaker volume only.
- Balance: Touch < or > for more sound from the left or right speakers. The middle position balances the sound between the left and right speakers.
- Fade: Touch ^ or v for more sound from the front or rear speakers. The middle position balances the sound between the front and rear speakers.

Tag Song (If Equipped) :

If equipped, touch to tag song information, including artist and title, to transfer to an iPod®. If the iPod is not attached, the information will be

transferred when it is attached. Touch OK to go back to the Now Playing view.

Timeshift (If Equipped) : Timeshift is the recording of a radio station for up to 25 minutes. See “Timeshifting” later in this section.

DSP Modes (If Equipped):

- Bose® Studio Surround® and Bose® Centerpoint® Surround sound system has four DSP modes:
 - Normal: Adjusts the audio to provide the best sound for all seating positions.
 - Driver: Adjusts the audio to provide the best sound for the driver.
 - Rear: Adjusts the audio to provide the best sound for the rear seat occupants.
 - Centerpoint: Turns on Bose Centerpoint surround technology. This setting creates a surround sound listening experience from nearly any audio source; existing stereo, CD collection,

satellite radio, and MP3 players. For more information on Bose Centerpoint surround technology, visit www.bose.com/centerpoint.

Auto Volume (If Equipped) : This feature adjusts the volume based on vehicle speed. The options are Off, Low, Medium - Low, Medium, Medium - High, or High.

Press  BACK to go back to the previous menu.

Bose AudioPilot noise compensation technology (If Equipped) : This feature adjusts the volume based on the noise in the vehicle and speed. When turned on, AudioPilot technology detects ambient noise and vehicle speed to continuously adjust many aspects of the audio signal so that music will sound the same at a set volume level.

The options are ON and OFF.

This feature is most effective at lower radio volume settings where background noise can affect how well the music is being played through the vehicle's audio system. A higher volume settings, where the music is louder than the background noise, there may be little or no adjustments by AudioPilot.

For more information on Bose AudioPilot noise compensation technology, see www.bose.com/audiopilot.



HD Radio (If Equipped) : For AM and FM only, touch to turn HD Radio® (if equipped) reception on or off. Press  BACK to go back to the previous menu.

Update Station List : For AM and FM only, touch to update the station list. Press  BACK to go back to the previous menu.

Finding a Station

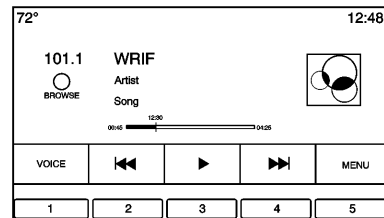
Seeking a Station



Press  or  on the faceplate to search for the previous or next strongest station.

Direct Tune (If Equipped)

Touch the TUNE screen button to switch to Direct Tune for manually searching for a station.

If not equipped with Direct Tune, touch the SEEK screen button to switch to TUNE. Touch again to change back. Turn the MENU knob to manually search for a station.

Storing Radio Station Presets

Favorites are stored in the area at the bottom of the screen.

Up to 60 preset stations can be stored under the following:

AM, FM, and XM (if equipped)

Radio Stations : Touch and hold a favorite screen button to save the current station as a favorite. Touch a favorite screen button in the favorite area to recall a favorite station.

Mixed-Audio Favorites

Favorites that can be stored include radio stations, media favorites, contacts, destinations, navigation, or applications.

72°					12:48				
WRIF	99.5	3	Mike	5					
99.5	Coffee	8	9	10					
11	Tag	Tone 1 •••	Tone 2	15					

To scroll through the favorites:

- Drag up on the top border of the favorites bar to view the favorites. To close the favorites, drag them down.
- Slide a finger to the right or left to scroll through each page of favorites.

Tone Settings : Touch and hold a screen button to save the current tone settings as a favorite in the tone settings screen. Drag up on the reveal button at the bottom to bring up favorites. Touch a favorite screen button in the favorite area to recall a favorite tone setting.

Pandora Radio Stations : Touch and hold a screen button to store the Pandora application. Pandora favorite stations work when Pandora is launched.

The number of favorites displayed is automatically adjusted by default, but can be manually adjusted in the Settings menu under Radio and then Number of Favorites Shown.

Timeshifting (If Equipped)

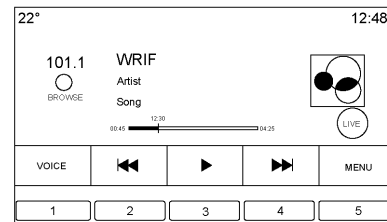

The audio system can record live radio for up to 25 minutes. When tuned to a station, the system automatically begins recording the audio along with the associated metadata.

Touch **II** to pause playback of the audio and to initiate timeshift mode. Touch **▶** to resume playback of the recorded audio.

When timeshifting begins, a time is indicated on the right of the play/pause indicator. This time indicates the time of day at which playback is paused. This time continues to show as long as the system is in a paused mode and the buffer continues to fill.

Buffer Reset

The buffer will reset anytime the broadcast band or stations/channels are changed. Changing to a media source while paused will not reset the buffer.

Rewinding or Fast Forwarding a Timeshifted Broadcast

- Touch and hold the rewind indicator to reverse playback at a rate of 10 times the rate of normal playback.
- Touch and hold the fast forward indicator to advance playback at a rate of 10 times the rate of normal playback. The timeshift buffer can be advanced up to the end of the timeshift buffer and return to live mode.

Returning to Live Broadcast

If listening to timeshifted radio, touch the fast forward indicator to return to live radio.

Timeshifting and Station/Channel Lists

If browsing a station/channel list is started while listening to the timeshift content, the list content is shown in live time not buffered time.

Skipping Back in a Broadcast

For programs with metadata, touching the previous button less than five seconds into a program will make the system skip to the beginning of the previous program. If more than five seconds into the current song/program, the system starts at the beginning of the current program. If no metadata is available, the system skips back 30 seconds.

Reaching the End of the Buffer

If the audio is paused and the 25-minute buffer is reached, the buffer continues recording content on a first-in, first-out basis. When playback is started, the content played will be the last 25 minutes in the buffer.

HD Radio Technology

If equipped, HD Radio Technology is a free service with features such as static-free sound, more programming choices on local FM, HD2, HD3, and higher, and on-screen information such as artist and song title.

HD Radio Technology Channel Access

To access HD Radio channels:

1. Tune the radio to the channel. HD Radio must be turned on in the Menu. If the channel is broadcasting HD Radio Technology, the radio will automatically switch to digital audio, indicated with an HD Radio Technology logo.
2. Press **◀◀** or **▶▶** on the faceplate or turn the MENU knob to tune to the previous or next HD Radio channel.

There may be a delay before the channel starts playing.

The HD Radio channel number is indicated next to the logo.

See *AM-FM Radio* ⇨ 17.

For a list of all channels, see www.hdradio.com.

HD Radio Technology Troubleshooting

Digital audio delay : Wait for the signal to process. This can take several seconds.

Volume change, audio skip, echo, digital audio lost : Channel signal strength may be weak or the channel is out of range. Verify proper reception on another channel.

If the HD Radio signal loses reception while listening to channel HD1, the radio will go back to the main non-HD Radio channel.

If the HD Radio signal loses reception while listening to channels HD2 to HD8, the radio mutes until the signal can be recovered or until the channel is changed.

Satellite Radio

SiriusXM® Satellite Radio Service (If Equipped)



Vehicles with a valid SiriusXM satellite radio subscription can receive SiriusXM programming.

SiriusXM satellite radio has a wide variety of programming and commercial-free music, coast to coast, and in digital-quality sound. See www.siriusxm.com or call 1-866-635-2349 in the U.S. In Canada, see www.xmradio.ca or call 1-877-209-0079.

When SiriusXM is active, the station name, number, category name, song title, and artist display on the screen.

SiriusXM Menu

SiriusXM has a menu to adjust different features.

Touching the MENU screen button may display the following:

Tone Settings : Touch + or – to adjust the tone settings. See *AM-FM Radio* ⇨ 17.

Tag Song : Press the Tag Song button to save song information that SiriusXM stations include in their broadcasts. You can then preview and purchase your tagged songs in the iTunes® store

When connected to iTunes, the Sync button on the device may need to be pressed to transfer the tags to iTunes.

TuneSelect : For SiriusXM only, this feature allows for an alert to be set for artists or songs that are played on any channel. Touch Manage Tune Select to turn the alerts On and Off or manage the saved selection of Artists or Songs. To turn off an alert, touch the Song or Artist

and uncheck the box. To delete an alert, touch -. Touch  Back to go back to the previous menu.

Auto Volume (If Equipped) : This feature adjusts the volume based on the vehicle speed. See *AM-FM Radio* ⇨ 17.

Bose AudioPilot® noise compensation technology (If Equipped) : This feature adjusts the volume based on the noise in the vehicle and speed. See *AM-FM Radio* ⇨ 17.

Radio Reception

Unplug electronic devices from the accessory power outlets if there is interference or static in the radio.

FM

FM signals only reach about 16 to 65 km (10 to 40 mi). Although the radio has a built-in electronic circuit that automatically works to reduce interference, some static can occur, especially around tall buildings or hills, causing the sound to fade in and out.

AM

The range for most AM stations is greater than for FM, especially at night. The longer range can cause station frequencies to interfere with each other. Static can also occur when things like storms and power lines interfere with radio reception. When this happens, try reducing the treble on the radio.

SiriusXM® Satellite Radio Service

If equipped, SiriusXM Satellite Radio Service provides digital radio reception. Tall buildings or hills can interfere with satellite radio signals, causing the sound to fade in and out. In addition, traveling or standing under heavy foliage, bridges, garages, or tunnels may cause loss of the SiriusXM signal for a period of time.

Cell Phone Usage

Cell phone usage, such as making or receiving phone calls, charging, or just having the phone on may

cause static interference in the radio. Unplug the phone or turn it off if this happens.

Fixed Mast Antenna



The fixed mast antenna will go through most car washes as long as it is securely attached. If the antenna becomes slightly bent, straighten it out by hand. If it is badly bent, replace it.

Occasionally check that the antenna is tight at the base. If tightening is required, protect the paint from damage.

Multi-Band Antenna

The roof antenna is for OnStar®, SiriusXM® Satellite Radio, and GPS (Global Positioning System). Keep clear of obstructions for clear reception. If the vehicle has a sunroof, and it is open, reception can also be affected.

Pandora Internet Radio

If equipped, Pandora® is a free Internet radio service that streams personalized radio stations based on songs, artists, tracks, genres, and comedians. Create stations using the Pandora website or Smartphone application, then use  (thumbs up) or  (thumbs down) to personalize stations. To set up an account, or for more information, go to www.pandora.com.

A phone or tablet with Internet connection and the Pandora application installed is required. Personal cell phone data plans are used. Make sure the latest version is installed on the device.

Launching Pandora

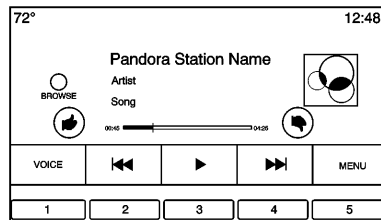

Connect the iPhone to the USB port, or connect Android™ or BlackBerry® through Bluetooth. See *Auxiliary Jack* ⇨ 32 or *Bluetooth (Overview)* ⇨ 87 or *Bluetooth (Infotainment Controls)* ⇨ 88 or *Bluetooth (Voice Recognition)* ⇨ 91. For first time use, set up the stations before connecting to the vehicle. The Pandora icon will be available on the Home Page.

When Pandora is chosen, the Pandora logo will populate on the screen and will display “Acquiring Pandora Radio Station.” Launch times can be significant.

Using the iPhone

1. Plug the device into the USB port. The phone screen must be unlocked.
2. Touch PANDORA on the Home Page to launch Pandora.
3. If nothing happens when the available PANDORA screen button is touched, download the latest Pandora application and retry.

The login screen may display on the device.

Using an Android or BlackBerry Phone

The BlackBerry phone must be unlocked to launch Pandora service.

1. Pair the phone using Bluetooth.
2. Launch Pandora directly from the Home Page by touching PANDORA.
3. If nothing happens when the available PANDORA screen button is touched, download the latest Pandora application and retry.

The login screen may display on the device.

Pandora Menu

Touch Menu on the Pandora main page.

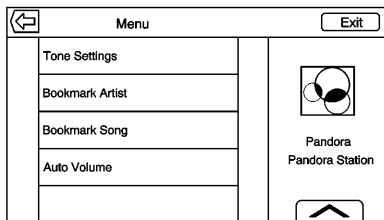

Pandora has a menu system with the following:

Tone Settings : Touch to adjust the tone settings. See *AM-FM Radio* ⇨ 17.

Bookmark Artist : Touch to bookmark the artist.

Bookmark Song : Touch to bookmark the song.

Auto Volume : This feature sets the auto volume based on the speed of the vehicle and noise in the vehicle. See *AM-FM Radio* ⇨ 17.

Bose AudioPilot : If equipped, this feature adjusts the volume based on the noise in the vehicle. See *AM-FM Radio* ⇨ 17.

Pandora Features

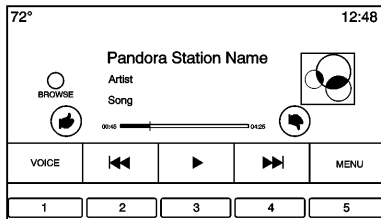

Pandora service has features to rate tracks, skip tracks, or change stations.

Thumbs Down : When touched, Pandora stores this information, changes to the next track, and does not play this track on this station again. This helps Pandora choose which tracks should not play on this station. This feature is only available on user created stations.

Thumbs Up : When touched, Pandora stores this information and is highlighted for the remainder of the track. This helps Pandora choose which tracks should play on this station.

Next Track : When touched, Pandora changes to the next track.

Play/Pause : Touch to play or pause playback.

Pandora Skip Limit

Pandora limits the number of skips allowed on their service. When the skip limit is reached, or next track will not skip the currently playing track, but the feedback will be recorded.

Advertisements on Pandora

Pandora may display advertisements. The artist name and track title will not be displayed and the skip track button will not be available.

Pandora Troubleshooting

Unable to Connect Device to Vehicle

If the device is unable to connect to the USB or Bluetooth:

1. Turn the vehicle off.
2. Take the Remote Keyless Entry (RKE) transmitter at least 6 m (20 ft) away from the vehicle.
3. Wait about 30 seconds, and try to connect the device again. See *Auxiliary Jack* ⇨ 32 or *Bluetooth (Overview)* ⇨ 87 or *Bluetooth (Infotainment Controls)* ⇨ 88 or *Bluetooth (Voice Recognition)* ⇨ 91.



Unable to Start Pandora

If the device is unable to launch Pandora:

- Check that the latest version of Pandora is installed.
- Check that there is an active account logged into Pandora.
- End a call. Pandora will not work during an active call.

- Have at least one station created.
- For Android and BlackBerry devices, check that the device is paired with the vehicle, and whether the device displays in the Connected phone sources list under the PHONE icon from the Home Page.
- For an iPhone, check that the USB cable is connected to the USB port and the screen is unlocked.
- Close Pandora on the device and launch again. Devices that allow multitasking may require an extra step to quit the Pandora application. See the cell phone manufacturer's user guide.

Thumbs Up or Thumbs Down Error

If there is an error trying to rate a track with the  or  buttons, the message "Thumbs Down Error" or "Thumbs Up Error" will display. Touch OK to dismiss.

Loss of Audio

Loss of Pandora audio can happen in different ways:

- Weak or lost data connection.
- Device needs to be charged.
- Application needs to be relaunched.
- Connection between phone and radio lost.
- An iPhone is connected to both Bluetooth and the USB port.

Playback can be resumed from a loss of audio by double tapping on the iPhone menu button then scrolling through the icons to find an icon that allows a change of flow between Bluetooth and USB cable.

Common Pandora Messages

Pandora Error/Please Check

Connected Device : Not signed in or Pandora is down for maintenance.

No Stations Available : No stations are available on the Pandora server through the connected device.

Action Unavailable Please Check

Device : A few conditions for loss of Internet connection are:

- The connected device loses its cellular connection.
- The device does not support Internet connectivity.
- The device is not in the vehicle.
- No Bluetooth signal.

No skips remaining for this station or permitted during advertisements:

- The maximum Pandora skip limit has been reached according to the plan that was obtained.
- Skipping an advertisement was tried.

See www.pandora.com/help. If the service will not work, see a dealer for assistance.

Audio Players

CD Player

If equipped, use the CD player to play CDs and MP3 audio.

The system can play:

- Most audio CDs
- CD-R
- CD-RW
- MP3 or unprotected WMA formats

When playing any compatible recordable disc, the sound quality can be reduced due to disc quality, the method of recording, the quality of the music that has been recorded, or the way the disc has been handled.

There can be increased skipping, difficulty in recording tracks, difficulty in finding tracks, and/or difficulty in loading and ejecting. If these problems occur, check the disc for damage or try a known good disc.

To avoid damage to the CD player:

- Do not use scratched or damaged discs.
- Do not apply labels to discs. The labels could get caught in the player.
- Insert only one disc at a time.
- Keep the loading slot free of foreign materials, liquids, and debris.
- Use a marking pen to label the top of the disc.

Loading and Ejecting Discs

To load a disc:

1. Turn the vehicle on.
2. Insert a disc into the slot, label side up. The player pulls it in the rest of the way. If the disc is damaged or improperly loaded, there is an error and the disc ejects.

Press  to eject a disc from the CD player. If the disc is not removed within a short period of time, it is automatically pulled back into the player.

Playing an Audio CD

Press the MEDIA faceplate button or press the Audio screen button on the Home Page until CD Audio Now Playing view is selected.

On the CD main page, a track number displays at the beginning of each track or Song, Artist, and Album information displays when available.

Use the following controls to play the disc:

(Previous/Fast Reverse):

- Press to seek to the beginning of the current or previous track. If the track has been playing for less than five seconds, it seeks to the previous track. If longer than five seconds, the current track starts from the beginning.
- Press and hold to fast reverse through a track. Release the button to return to playing speed. Elapsed time displays.

▶ (Next/Fast Forward):

- Press to seek to the next track.
- Press and hold to fast forward through a track. Release the button to return to playing speed. Elapsed time displays.

For vehicles equipped with Rear Seat Entertainment (RSE), use the Video application to play Blu-ray® or DVD discs.

Storing Media Favorites

To store media favorites, touch and hold a favorite button to display a list of media types for the currently playing item. Select from this list.

The lists that may display are:

Genres : Touch to store the current genre as a favorite. Touch a screen button in the favorite area to recall a favorite genre. The first song of the genre begins to play.

Artists : Touch to store the current artist as a favorite. Touch a screen button in the favorite area to recall a favorite artist. The first song in the artist list begins to play.

Albums : Touch to store the current album as a favorite. Touch a screen button in the favorite area to recall a favorite album. The first song in the album list begins to play.

Playlists : Touch a screen button in the favorite area to recall a favorite playlist. The first song in the playlist begins to play.

Songs : Touch to store the current song as a favorite. Touch a screen button in the favorite area to recall a favorite song.

Podcasts or Podcast Episode : Touch and hold a screen button to store the current podcast as a favorite. Touch a screen button in the favorite area to recall a favorite podcast or podcast episode. The podcast or podcast episode begins to play.

Audiobooks : Touch and hold a screen button to save the current audiobook as a favorite. The first chapter begins to play. Touch a screen button in the favorite area to recall a favorite audiobook.

Videos : Touch and hold a screen button to store the current video as a favorite. Touch a screen button in the favorite area to recall a favorite video. Not all formats are supported.

Error Messages

If Disc Error displays and/or the disc comes out, it could be for one of the following reasons:

- The disc has an invalid or unknown format.
- The road is very rough. Try the disc again when the road is smoother.
- The disc is dirty, scratched, wet, or upside down.
- The air is very humid. Try the disc again later.
- There was a problem while burning the disc.
- The label is caught in the CD player.

If Disc Player Error displays, it could be for one of the following reasons:

- The player temperature is too high.

- There are load or eject errors.

If the CD is not playing correctly, for any other reason, try a known good CD.

If any error continues, contact your dealer.

Playing an MP3 CD

To play an MP3 CD, follow the same instructions as “Playing an Audio CD.”

The following guidelines must be met when creating an MP3 disc, otherwise the CD might not play:

- Sampling rate: 16 kHz, 22.05 kHz, 24 kHz, 32 kHz, 44.1 kHz, and 48 kHz.
- Bit rates supported: 8, 16, 24, 32, 40, 48, 56, 64, 80, 96, 112, 128, 144, 160, 192, 224, 256, and 320 kbps.
- Recorded on a CD-R or CD-RW.

MP3 CD playback is unavailable when both screens in the rear seat area are in use. Turn off one of the rear screens to allow MP3 playback.

MP3 Music Menu

Press the MENU button while that source is active to access the menu.

Touch any of the following buttons on the MP3 Menu:

Shuffle: Touch to play the tracks randomly. Touch again to stop shuffle.

Auto Volume (If Equipped): This feature adjusts the volume based on the speed of the vehicle. See *AM-FM Radio* ⇨ 17.

Tone Settings : Touch + or – to adjust Bass, Midrange, Treble, or Surround. See *AM-FM Radio* ⇨ 17.

MP3 Folder Information

Touch anywhere between the top applications tray and the bottom menu to display the browse screen.

Root Directory : To access, touch the screen anywhere between the top and bottom menu or touch BROWSE. The root directory is treated as a folder. All files

contained directly under the root directory are accessed prior to any root directory folders.

No Folder : When the CD only contains compressed audio files without any folders or playlists, all files are under the root folder.

File System and Naming : The song titles, artists, albums, and genres are taken from the file's ID3 tag and are only displayed if present in the tag. If a song title is not present in the ID3 tag, the radio displays the file name as the track name.

USB Port

The vehicle may have USB ports in the center console, in the armrest, in the upper glove box, in the storage bin behind the radio (if equipped) and if equipped with Rear Seat Entertainment (RSE), there may be one USB port in the rear media console storage area.

The system is optimized to support two connected devices with a total of 15,000 songs.

Playing from a USB

A USB mass storage device can be connected to the USB port.

Gracenote®

When plugging in a USB device, Gracenote service builds voice tags for music. Voice tags allow artists, albums with hard to pronounce names, and nicknames to be used to play music through voice recognition.

While indexing, infotainment features are available.

My Media Library

Allows access to content from all indexed media sources. Touch the MEDIA screen button to scroll through the options until My Media is selected. Use gestures or screen buttons to scroll through the content.

USB MP3 Player and USB Drives

- The USB MP3 players and USB drives connected must comply with the USB Mass Storage Class specification (USB MSC).

- Hard disk drives are not supported.
- The following restrictions apply for the data stored on a USB MP3 player or USB device:
 - Maximum folder structure depth: 11 levels.
 - Applicable audio extensions are mp3, wma, aac, m4a, and aif.
 - WMA and Apple lossless files are not supported.
 - Supported file systems are FAT32 and NTFS.

To play a USB device, do one of the following:

- Connect the USB.
- Press MEDIA until the connected device is shown.

Use the following when playing an active USB source:

▶ **(Play)** : Press to play the current media source.

|| **(Pause)** : Press to pause play of the current media source.

◀ **(Previous/Reverse):**

- Press to seek to the beginning of the current or previous track. If the track has been playing for less than two seconds, the previous track plays. If playing longer than 2–5 seconds, depending on the device, the current track restarts.
- Press and hold to reverse quickly through playback. Release to return to playing speed. Elapsed time displays.

▶ **(Next/Forward):**

- Press to seek to the next track.
- Press and hold to advance quickly through playback. Release to return to playing speed. Elapsed time displays.

USB Menu

Touch Menu to display the USB menu. The following may be available:

Shuffle: Touch to play the tracks randomly. Touch again to stop shuffle.

Auto Volume (If Equipped): This feature adjusts the volume based on vehicle speed. The options are Off, Low, Medium-Low, Medium, Medium-High, or High.

Bose AudioPilot® noise compensation technology (If Equipped): This feature adjusts the volume based on the noise in the vehicle and speed. See *AM-FM Radio* ⇨ 17.

Tone: Touch + or – to adjust the tone settings. See *AM-FM Radio* ⇨ 17.

USB Browse Menu

Touch anywhere between the top and bottom menus or touch the BROWSE button to view the browse menu and the following options are displayed along the bottom of the screen:

Playlists:

1. Touch to view the playlists stored on the USB.
2. Select a playlist to view the list of all songs in that playlist.

3. Select a song from the list to begin playback.

Artists:

1. Touch to view the list of artists stored on the USB.
2. Select an artist name to view a list of all albums by the artist.
3. To select a song, touch All Songs or touch an album and then select a song from the list.

Albums:

1. Touch to view the albums on the USB.
2. Select the album to view a list of all songs on the album.
3. Select a song from the list to begin playback.

Songs:

1. Touch to display a list of all songs on the USB.
2. To begin playback, select a song from the list.

Genres:

1. Touch to view the genres on the USB.

2. Select a genre to view a list of artists.
3. Select an artist to view albums by that artist.
4. Select an album to view songs on the album.
5. Select a song to start playback.

Podcasts, Composers, Audiobooks, Videos, and Folder View are shown when More is selected from the bottom of the screen.

Podcasts:

1. Touch to view the podcasts on the USB.
2. Select a podcast.
3. Select an episode to start playback.

Composers:

1. Touch to view the composers on the USB.
2. Select Composers to view a list of albums by that composer.
3. Select an album to view a list of songs.

4. Select a song from the list to begin playback.

Audiobooks:

1. Touch to view the audiobooks stored on the device.
2. Select the audiobook from the list. Select a chapter to begin playback.

Folder View (If Equipped):

1. Touch to view the directories on the USB.
2. Select a folder to view a list of all files.
3. Select a file from the list to begin playback.

File System and Naming

The songs, artists, albums, and genres are taken from the file's song information and are only displayed if present. The radio displays the file name as the track name if the song information is not available.

Supported Apple® Devices

To view supported devices in the U.S., see my.chevrolet.com/learned.

To view supported devices in Canada, see chevroletowner.ca.

Loss of Audio

If a phone currently paired over Bluetooth is plugged in with a USB cable, the system will automatically mute the phone audio. Playback can be resumed by changing the audio source from Bluetooth to USB cable.

Source USB from the Audio MEDIA screen button to resume playback.

Bluetooth Streaming Audio and Voice Recognition

See *Bluetooth Audio* ⇨ 33 for information using voice recognition with Bluetooth streaming audio.

Make sure all devices have the latest software downloaded.

SD Card Reader

If equipped, this vehicle has an SD card reader in the center console, and one in the Rear Seat Entertainment (RSE) system, if equipped.

The SD card reader is for audio and video playback and uses the same controls as the USB port. Playback from an SD card follows the same file formats and restrictions defined under *USB Port* ⇨ 29. Not all video formats are supported.

Set up the SD card while the vehicle is in P (Park). See "Audio" under *Using the System* ⇨ 13.

Place the card into the card reader.

If an SD card has already been connected, but a different source is currently active, touch the MEDIA screen button to scroll through the audio source screens until USB/SD card displays.

Viewing photos is supported on the RSE SD card reader.

Auxiliary Jack

This vehicle has an auxiliary input jack in the center console under the armrest. Possible auxiliary audio sources include:

- Laptop computer
- Audio music player

This jack is not an audio output. Do not plug headphones into the auxiliary input jack. Set up an auxiliary device while the vehicle is in P (Park).

Connect a 3.5 mm (1/8 in) cable from the auxiliary device to the auxiliary input jack. When a device is connected, the system can play audio from the device over the vehicle speakers.

If an auxiliary device has already been connected, but a different source is currently active, press the MEDIA faceplate button or touch the MEDIA screen button to scroll through audio source screens, until AUX Input source screen displays.

Playing from the AUX Port

An auxiliary device is played through the audio system and controlled through the device itself.

AUX Menu

Press the MENU knob to display the AUX Input menu and the following may display:

Tone Settings : Select to adjust Bass, Midrange, Treble, Balance, Fade, and EQ (Equalizer). See *AM-FM Radio* ⇨ 17.

Auto Volume (If Equipped) : This feature adjusts the volume based on the vehicle speed. See *AM-FM Radio* ⇨ 17.

Bose AudioPilot® (If Equipped) : This feature can be turned on or off. See “Bose AudioPilot” in *AM-FM Radio* ⇨ 17.

EQ (Equalizer) Settings : If equipped, this feature adjusts the pre-defined EQ modes. See “EQ (Equalizer) Settings” in *AM-FM Radio* ⇨ 17.

DSP Modes (If Equipped) : Bose® Studio Surround® and Bose Centerpoint® Surround sound system, adjusts the DSP modes. See “DSP Modes” in *AM-FM Radio* ⇨ 17.

Bluetooth Audio

If equipped, music may be played from a paired Bluetooth device. See *Bluetooth (Overview)* ⇨ 87 or *Bluetooth (Infotainment Controls)* ⇨ 88 or *Bluetooth (Voice Recognition)* ⇨ 91 for help pairing a device.

The music can be controlled by either the infotainment controls or the controls on the device.

Music can be launched by pressing the MEDIA faceplate button or touching the MEDIA screen button on the Home Page.

To play music via Bluetooth:

1. Power on the device, and pair to connect the device.
2. Once paired, go into the audio application from the Home Page or through the applications tray. Select MEDIA until Bluetooth displays.

Bluetooth Audio Menu

Touch the MENU screen button or MENU knob to display the Bluetooth Audio menu. The following may be available:

Auto Volume (If Equipped): This feature adjusts the volume based on vehicle speed. The options are Off, Low, Medium-Low, Medium, Medium-High, or High.

Bose AudioPilot (If Equipped): This feature adjusts the volume based on the noise in the vehicle and speed. See *AM-FM Radio* ⇨ 17.

Tone: Touch + or – to adjust the tone settings. See *AM-FM Radio* ⇨ 17.

Touch  Back to go back to the previous menu.

Manage Bluetooth Devices: Touch to go to the Bluetooth page to add or delete devices.

When using the Bluetooth audio source, the radio may not be able to launch specific applications on your device. Use the device to start audio playback when it is safe to do so.

All devices launch audio differently. When selecting Bluetooth audio as a source, the radio may show as paused on the screen. Press play on the device or press  to begin playback.

Some phones support sending Bluetooth music information to display on the radio. When the radio receives this information, it will check to see if any is available and display it. For more information about supported Bluetooth features, see www.gm.com/bluetooth.

OnStar System

OnStar® with 4G LTE



If equipped with OnStar 4G LTE, up to seven devices, such as smartphones, tablets, and laptops, can be connected to high-speed Internet through the vehicle's built-in Wi-Fi hotspot.

Call 1-888-4-ONSTAR (1-888-466-7827) to connect to an OnStar Advisor for assistance. See www.onstar.com for a detailed instruction guide, vehicle availability, details, and system limitations. Services and apps vary by make, model, year, carrier, availability, and conditions. 4G LTE service is available in select markets. 4G LTE performance is based on industry

averages and vehicle systems design. Some services require a data plan.

Rear Seat Infotainment

Rear Seat Entertainment (RSE) System

If equipped, the system includes a Blu-ray/DVD/CD player, USB, SD, audio/video jacks, wireless headphones, and a remote control.

The remote control is used to select the same or a different source for each screen from the rear seats.

Video can be viewed from the front by touching the Video screen icon, if the vehicle is in P (Park). Audio will be heard over the speakers. If another screen icon is selected, the video on the rear screen will continue to play but the audio on the speakers will change to the source selected.

To resume play of the video where it left off, Pseudo Resume must be on. See "Player Setup BD/DVD" later in this section.

The RSE system may not operate properly until the temperature is above -20°C (-4°F) and below 55°C (131°F).

System Operation

The second and third row video screens are in the overhead.

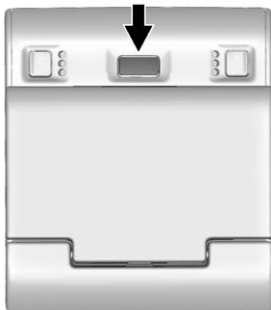

To use:

1. Press the release button in front of the overhead screen. Do not pull on the sides of the screen.



2. Move the screen to the viewing position. Remove the remote from the storage location to use.

Caution

When storing the remote, place it in the storage area with the buttons facing toward you or damage to the screen could occur.

- Opening a screen will turn the system on. If the screens are open with the system off, press the power button on the remote to turn the system on.

The system can also be turned on from the front infotainment system by touching the Video screen button. After selected, another item can be selected from the Home Page and the video and audio will continue to play in the rear.

Push the video screen into its locked position when it is not in use. The screen turns off automatically.

The audio may continue with the screens down. This allows listening to music without the screen on. To turn the audio off, press the power button on the remote or on the front infotainment Video screen.

Caution

Avoid directly touching the video screen, as damage may occur.

Sources

Sources include AM, FM, XM (if equipped), AUX, Photos, BD (Blu-ray disc), CD/DVD, USB, and SD card.

Menus and Features

AM/FM Menu

Press RADIO on the remote control, then select AM or FM.

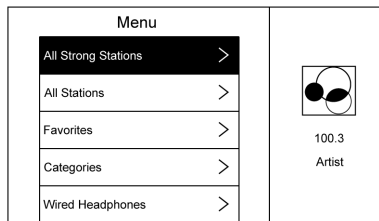

Press Menu on the remote control to select All Strong Stations, All Stations, Favorites, Categories, Wired Headphones, DivX[®] VOD if supported, or Software Information.

Only one tuner source may be active at a time.

To close, press the MENU button or  (Back) button, or wait for the time out.

XM Menu (If Equipped)

Press RADIO on the remote control, then select XM.

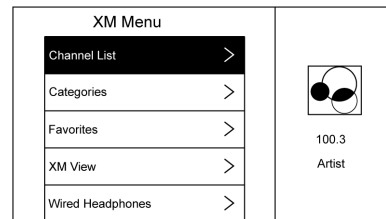

Touch Menu to select Channel List, Categories, Favorites, XM View, Wired Headphones, DivX VOD if supported, or Software Information.

Only one tuner source may be active at a time.

To close, press the MENU button or  (Back) button, or wait for the time out.

Disc Menu BD (Blue-ray disc)

Press MEDIA on the remote control, then select CD/DVD/BD, USB, SD, AUX, or Photo Viewer.

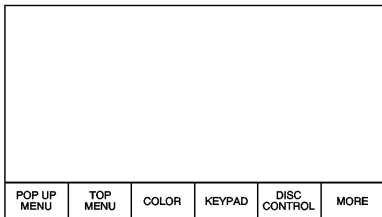

Press MENU on the remote control once to display menus based on the media.

Choose from POP UP MENU (BD Only), TOP MENU, COLOR, KEYPAD, DISC CONTROL, and MORE (SETTINGS, PREVIOUS, NEXT, STILL OFF).

To close, press the MENU button or  (Back) button, or wait for the time out.

Disc Menu DVD

Press MENU on the remote control once to select from TOP MENU, KEYPAD, STOP DISC, PHOTO, and SETTINGS.

To close, press MENU or  (Back), or wait for the time out.

CD Menu

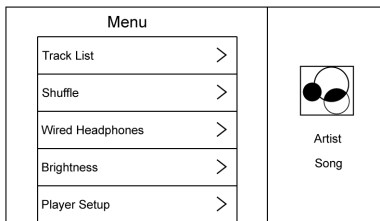

Select from:

- Track List
- Shuffle
- Disc Information (if available)
- Wired Headphones
- Brightness

- Player Setup: Audio Compression, Auto Enter (if available)
- DivX VOD (if supported)
- Title Search (if available)
- Software Information

If no disc is present, not all choices are available.

Pop Up Menu (BD Only)

Select to display the on-screen menu options. Touch the disc-generated option to close the Pop Up menu and return to the audio screen, if available, or make a selection to exit the Pop Up menu. When the Pop Up menu is opened, the overlay/interaction selector menu will be closed.

Top Menu BD/DVD

Select to display the DVD or BD menu. Make a selection to exit the Top menu. TOP MENU is not available for BDAV, DVD-VR, and AVCREC.

Color (BD Only)

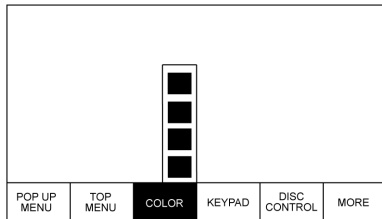

Select to display the four color button options. Highlight a color and press ENTER and the appropriate action for that disk will be carried out. To close the menu, press (Back) or MENU, or wait for the time out. Press the down arrow to keep the overlay menu up, but close the Color menu.

Keypad BD/DVD

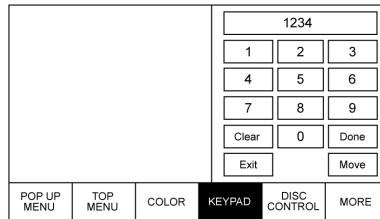

Select to display. To close, press (Back) or MENU, wait for the menu to time out, or press the down arrow from the 0 or Done buttons. The keypad is disc dependent and may have no function.

The keypad input is limited to four digits.

Select Clear to clear one digit at a time. Press and hold to clear all entered digits.

Disc Control (BD/AV and BDMV Only)

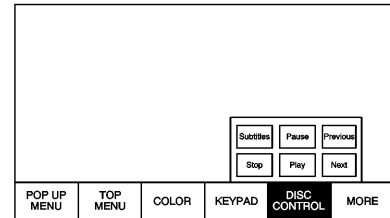

Select to display the disc options Subtitles, Play, Pause, Next, Previous, and Stop. Press (Back) or MENU, or wait for the time out to close. Press the down arrow from Stop, Play, or Next to keep the overlay up but close the menu. The Disc Control menu is disc dependent and may have no function.

Stop Disc (DVD Only)

Select to close the overlay menu. Touch Menu on the screen to open the Disc Stopped menu.

Select from:

- Resume Playback: Returns to the current position on the disc and resumes play.
- Title Search (if available)
- Restart Disc
- Screen Mode
- Wired Headphones
- Brightness
- Player Setup: Audio Compression, Auto Enter (if available)
- DivX VOD (if supported)
- Software Information

Not all options are available while the disc is playing.

Browse Media (AVCREC, BDAV, DVD-A, DVD-VR only) allows the media on the disc to be searched in a list format.

More

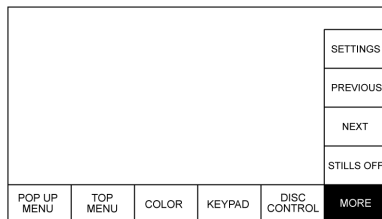

The MORE submenu includes SETTINGS and items related to still pictures.

Previous/Next/Stills Off

Select PREVIOUS to turn off or advance to the next still picture. NEXT advances to the next picture. Select STILLS OFF to return to the home still, if available.

Press  (Back) or MENU, or wait for the time out to close the menu.

Press the down arrow on the bottom option to close the next still pop-up. The still picture feature is disc dependent.

This feature can also be accessed by selecting Photo on the DVD Disc menu.

Settings BD/DVD

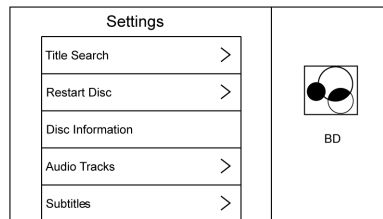

Select to access:

- Browse Media (BDAV, AVCREC, DVD-A, DVD-VR only): Allows browsing by Video List or Playlist.
- Title Search (AVCHD, DVD-V, BDMV only): Allows the titles provided by the disc to be searched. Select this option to bring up a keypad to search for specific titles.
- Restart Disc: Restarts the disc from the beginning.
- Disc Information (if available)
- Audio Tracks
- Subtitles

- Angle (BDMV, DVD-V, DVD-A only): Select an angle by using the up and down arrows to highlight the option and pressing ENTER or the right arrow.
- Screen Mode: Adjusts the framing on the RSE display. Select Normal, Wide, or Zoom. Screen Mode only applies to video sources and should be maintained if the disc is ejected.
- Wired Headphones: Use to listen to audio on the wired headphones. The headphone audio plays depending on which screen is selected. The default is screen 1 audio.
- Brightness: Increase the brightness by using the up or right arrow and decrease the brightness by using the down or left arrow. Each screen brightness can be adjusted separately.
- Player Setup: See "Player Setup BD/DVD" later in this section.
- DivX VOD (if supported)
- Software Information

Player Setup BD/DVD

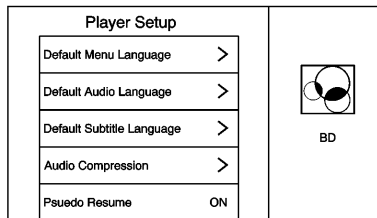

Player Setup may include:

- Default Menu Language: With no disc inserted, select from a list of languages or enter a language code.
- Default Audio Language: With no disc inserted, select from a list of languages or enter a language code.
- Default Subtitle Language: With no disc inserted, select from a list of languages or enter a language code.
- Audio Compression: When on, the RSE will attempt to reduce the difference between the audio highs and lows. CUSTOM will increase dialog volume.
- Pseudo Resume: When on, the RSE will attempt to resume play of the video where it left off after the vehicle has been turned off. This can be turned on or off.
- Auto Enter: When on, the RSE will attempt to start play of the video when the disc is inserted. This feature can be turned on or off. Not all discs support this feature.
- Audio Channel (AVCREC, DBAV, DVD-VR only) contains: Stereo, Left Mono, and Right Mono. Audio Channel is available from the Settings menu. Default will be determined by the disc.
- Format Internal User Memory: Only shown when no disc is inserted. Select OK. A message and the activity indicator display. A message displays when the format is complete.

42 Rear Seat Infotainment

Enter Language Code

Enter the desired language code.

Language/Code		User Code
Japanese	JPN	7465
English	ENG	6978
French	FRA	7082
German	DEU	6869
Italian	ITA	7384
Spanish	SPA	6983
Dutch	NLD	7876
Russian	RUS	8285
Chinese	ZHO	9072
Korean	KOR	7579
Greek	ELL	6976
Afar	AAR	6565
Abkhazian	ABK	6566
Afrikaans	AFR	6570
Amharic	AMH	6577
Arabic	ARA	6582
Assamese	ASM	6583

Aymara	AYM	6589
Azerbaijani	AZE	6590
Bashkir	BAK	6665
Byelorussian	BEL	6669
Bulgarian	BUL	6671
Bihari	BIH	6672
Bislama	BIS	6673
Bengali	BEN	6678
Tibetan	BOD	6679
Breton	BRE	6682
Catalan	CAT	6765
Corsican	COS	6779
Czech	CES	6783
Welsh	CYM	6789
Danish	DAN	6865
Bhutani	DZO	6890
Esperanto	EPO	6979
Estonian	EST	6984
Basque	EUS	6985
Persian	FAS	7065

Finnish	FIN	7073
Fiji	FIJ	7074
Faroese	FAO	7079
Friesian	FRY	7089
Irish	GLE	7165
Scots-Gaelic	GLA	7168
Galician	GLG	7176
Guarani	GRN	7178
Gujarati	GUJ	7185
Hausa	HAU	7265
Hindi	HIN	7273
Croatian	HRV	7282
Hungarian	HUN	7285
Armenian	HYE	7289
Interlingua	INA	7365
Interlingue	ILE	7369
Inupiak	IPK	7375
Indonesian	IND	7368
Icelandic	ISL	7383
Hebrew	HEB	7269

Yiddish	YID	8973
Javanese	JAV	7487
Georgian	KAT	7565
Kazakh	KAZ	7575
Greenlandic	KAL	7576
Cambodian	KHM	7577
Kannada	KAN	7578
Kashmiri	KAS	7583
Kurdish	KUR	7585
Kirghiz	KIR	7589
Latin	LAT	7665
Lingala	LIN	7678
Laothian	LAO	7679
Lithuanian	LIT	7684
Latvian	LAV	7686
Malagasy	MLG	7771
Maori	MRI	7773
Macedonian	MKD	7775
Malayalam	MAL	7776
Mongolian	MON	7778

Moldavian	MOL	7779
Marathi	MAR	7782
Malay	MSA	7783
Maltese	MLT	7784
Burmese	MYA	7789
Nauru	NAU	7865
Nepali	NEP	7869
Norwegian	NOR	7879
Occtian	OCI	7967
Oromo	ORM	7977
Oriya	ORI	7982
Panjabi	PAN	8065
Polish	POL	8076
Pashto, Pushto	PUS	8083
Portuguese	POR	8084
Quechua	QUE	8185
Rhaeto-Romance	ROH	8277
Kirundi	RUN	8278
Romanian	RON	8279
Kinyarwanda	KIN	8287

SanSkrit	SAN	8365
Sindhi	SND	8368
Sangho	SAG	8371
Serbo-Croatian	SCR	8372
Singhalese	SIN	8373
Slovak	SLK	8375
Uzbek	UZB	8590
Vietnamese	VIE	8673
Volapuk	VOL	8679
Wolof	WOL	8779
Xhosa	XHO	8872
Yoruba	YOR	8979
Zulu	ZUL	9085
Slovenian	SLV	8376
Samoan	SMO	8377
Shona	SNA	8378
Somali	SOM	8379
Albanian	SQI	8381
Serbian	SRP	8382
Siswaiti	SSW	8383

Sesotho	SOT	8384
Sundanese	SUN	8385
Swedish	SWE	8386
Swahili	SWA	8387
Tamil	TAM	8465
Telugu	TEL	8469
Tajik	TGK	8471
Thai	THA	8472
Tigrinya	TIR	8473
Turkmen	TUK	8475
Tagalog	TGL	8476
Setswana	TSN	8478
Tonga	TON	8479
Turkish	TUR	8482
Tsonga	TSO	8483
Tatar	TAT	8484
Twi	TWI	8487
Ukrainian	UKR	8575
Urdu	URD	8582

Errors

Errors can occur if the local storage area has been broken or if the ignition is turned off during formatting. Closing the screen during formatting will not interrupt it. If the screen is opened again, the current state of format will be displayed. If an error occurs, the Error screen will display when the ignition is turned on.

Wired Headphones

Select from the Settings menu, then select the headphone audio for the wired headphone jack based on screen 1 or screen 2 and press ENTER or the right arrow. Press  (Back) to exit.

The headphones are set to screen 1 by default.

Title Search (CD-DA Only)

This displays a list of titles to select by using the up and down arrows.

Disc Information (CD-DA Only)

If the inserted disc is BDMV, BDAV, AVCHD, AVCREC, DVD-Video, or DVD-VR the disc title should display. If the inserted disc is DVD-Audio, DTS-CD, CDDA, or Mixed-CD the track number will display.

DivX®

If supported, this indicates the vehicle is registered to play DivX media and explains how to obtain more information.

Software Information

This allows access to Version information, Save Vehicle Info to USB, and Open Source Info.

Save Vehicle Info to USB allows the current version to be saved to a jump drive, which must be done before an update can be performed.

Open Source Info shows where software information can be found.

Changing Between SCREEN 1 and SCREEN 2

Only one source at a time can be viewed on the overhead screen.

Either screen can access any available source.

Press SCREEN 1 or SCREEN 2 on the remote control to change which source displays on the overhead screen.

When screen 1 is displayed and SCREEN 2 on the remote control is pressed, the source for screen 2 will display. The audio for screen 1 is available on channel 1 of the headphones and the audio for screen 2 is available on channel 2 of the headphones. Change the channel on the headphones to the desired screen source.

One user can listen to the audio from screen 1 and view the source on the overhead display while another user can listen to a separate audio source by changing the channel on the wireless

headphones or setting their wired headphones to SCREEN 2 in the MENU.

RSE Controls Available from the Front Screen

To access the RSE, select Video from the HOME screen. The Video app may also be selected from the applications tray if it has been stored in one of the five locations.

Sourcing to DVD/BD

This allows for watching a DVD/BD video on the front screen when the vehicle is in P (Park).

After a disc is inserted, it will automatically begin playing. To resume play of the video where it left off, Pseudo Resume must be on. See "Player Setup BD/DVD" previously in this section.

With the vehicle in P (Park), icons display along the bottom of the front screen. When a DVD, VCD, USB, AUX, or SD is inserted:



When a BD is inserted:



Rear Media

This allows for transitioning between AUX, Disc, USB, and SD sources for the rear screens. Sources selected will be automatically sourced for both rear screens and will begin playback from the first available file.

The video will only appear on the front screen with the vehicle in P (Park). In any other gear, the front screen displays the active media source.

DVD/BD Disc Menu

With the vehicle in P (Park), touch DISC MENU to access the DVD/BD disc menu.

Next Track/Previous Track

Use ► to skip ahead or ◀ to skip back chapters. Press ◀ less than five seconds into the current track to start at the beginning of the previous track. Press ◀ more than five seconds into the current track to start at the beginning of the current track.

Fast Forward/Fast Rewind

With the vehicle in P (Park), hold ► or ◀ for approximately one and one-half seconds to fast forward or fast rewind. If ► or ◀ are held for approximately six seconds, the rate of fast forward or fast rewind will increase.

Play/Pause

Press ► to play or || to pause, depending on the current selection.

Keypad for DVD/VCD/SD/USB

With the vehicle in P (Park), select to display the DVD keypad. DVD keypad functionality is disc dependent and may not be available on all DVDs. Up to four digits can be entered. Select Clear to remove one digit in the entry field. Touch and hold Clear to remove all digits in the entry field.

Pop Up Menu (BD Only)

This displays the pop up menu contents for the BD. Make a selection or use the Interaction Selector to exit pop up menu view.

Cursor

Use to navigate and select items in the disc menu. Press the up, down, right, or left arrows, or ENTER. Press cursor to close the Interaction Selector and display a vertical menu of cursor buttons. The cursor will time out and close.

Sourcing USB/SD/VCD/AUX with Video

This allows for watching videos on the front screen from devices plugged into the rear module when in P (Park).

With the vehicle in P (Park), icons display:



These features will function the same as in DVD/BD sources, with the following exceptions:

- KEYPAD is only available for VCD in P (Park).
- DISC MENU is only available for disc sources such as VCD. The system displays the menu provided by the disc.

Sourcing DVD/BD/USB/SD/VCD/AUX

With the vehicle in D (Drive), the following icons display along the bottom of the front screen when one of these sources is active:



DVD/BD/USB/SD/VCD: All buttons are available.

AUX: Only REAR MEDIA and MENU are available.

Rear Media

Use to select AUX, Disc, USB, or SD sources. Both rear screens will be sourced and will begin playback of the first available file. The video will only display on the front screen if the vehicle is in P (Park). In any other gear, the front screen displays the active media source.

Previous Track/Next Track

Press ◀ or ▶ to select the previous or next track on the current media.

Play/Pause

Press ▶ to play or || to pause, depending on the current selection.

Menu (DVD/BD/SD/USB/AUX/VCD)

Only available in D (Drive). Press MENU to display these options:

- **Tone Settings:** Use to set bass, mid, and treble on speakers only. Once set, tone settings are for all sources.
- **Auto Volume Control:** Adjusts the volume of the audio based on the speed or ambient noise of the vehicle. Some vehicles may be equipped with the Bose AudioPilot system. In these cases, the Auto Volume main menu item is replaced with the Bose AudioPilot menu item. AVC or Bose AudioPilot is available to use with any source mode.

- **Traffic Announcements:** Displays traffic alerts in the RSE system. The video will continue to play and the audio will mute, depending on the alert.

Closing the Menu (DVD/BD)

Touch Back or Exit to close a menu. This will return to the previously viewed screen.

Power

Press the power button on the front screen to turn the RSE screen on or off. The front screen will continue to operate when the overhead screen is turned off. A red lit power button indicates the rear screens are on. A white lit power button indicates the rear screens are off.

Headphones

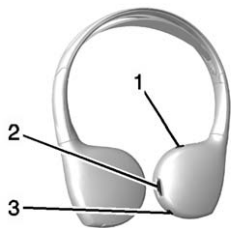

1. Power Button
2. Volume Control
3. Channel 1 or 2 Switch

RSE includes two or four 2-channel wireless headphones, depending on the vehicle model.

Press the power button to turn on the headphones. A light on the headphones comes on. If it does not come on, check the batteries. Intermittent sound or static can also indicate weak batteries. See “Battery Replacement” later in this section.

Turn the headphones off when not in use.

Move the channel switch to channel 1 or channel 2. Channel 1 will play audio from screen 1 and channel 2 will play audio from screen 2. When a third row screen is available, the screen will display the selection related to “1” on the remote control. If 1 is not available, press “2” on the remote control. Channel 2 will provide audio based on its setting.

- Screen 1 is overhead in the second row.
- Screen 2 is overhead in the third row.

Infrared transmitters are on the top of the second row video screen. The headphones shut off automatically if the RSE system is off or if the headphones are out of range of the transmitters for more than three minutes. Moving too far forward or stepping out of the vehicle can cause the headphones to lose the signal or have static.

Use the volume control on the headphones to adjust the volume.

For best audio performance, wear the headphones as indicated with L (Left) and R (Right) on the ear pads. Do not let anything cover the ear pads.

Caution

Do not store the headphones in heat or direct sunlight. This could damage the headphones and repairs will not be covered by the warranty. Storage in extreme cold can weaken the batteries. Keep the headphones stored in a cool, dry place.

If the foam ear pads become worn or damaged, the pads can be replaced separately. To purchase replacement ear pads, call 1-888-293-3332 or contact your dealer.

Battery Replacement

To change the batteries:

1. Loosen the screw to the battery door on the left side of the headphones.

2. Open the battery door.
3. Replace the two AAA batteries.
4. Replace the battery door and tighten the screw.

Auxiliary Inputs

Audio/Video (A/V) Jacks



1. Wired Headphone Volume Control
2. Wired Headphone Jack
3. A/V Jacks
4. USB Port
5. SD Card Slot

If equipped with RSE, features above will be in the rear of the center console. These ports are for the primary use of the rear passengers and not all media is available to the front passengers.

The A/V jacks allow audio or video cables to be connected from an auxiliary device such as a camcorder, video game system, or Apple device. A cable from Apple is required.

The A/V jacks are color coded:

- Yellow for video input.
- White for left audio input.
- Red for right audio input.

Power for auxiliary devices is not supplied by the infotainment system.

To use the auxiliary inputs of the RSE system:

1. Connect the auxiliary device cables to the A/V jacks.
2. Power on both the auxiliary device and the RSE video screen.

3. Press Media on the remote control and use the left or right arrows to change the source to AUX.

USB/SD

This allows for video and audio playback of supported media.

Audio from these ports can only be heard and controlled by the rear seat passengers. Video can be heard, shown, and controlled by the rear and front passengers.

To use the USB and SD:

1. Insert the device into the appropriate slot.
2. Select the source from the rear screen menu with the remote control MEDIA button.
3. Select the source from the front by pressing the Video application on the HOME screen.

Audio Output

Audio from a Blu-ray/DVD/CD player or auxiliary inputs can be heard through:

- **Wireless headphones:** Available for any source depending on the selected channel.
- **Vehicle speakers:** Touch the VIDEO screen button. Select any other source to stop the speaker audio.
- **Vehicle wired headphone jack:** See “Wired Headphone Jack” following.

The RSE system transmits the audio signal to the wireless headphones if an audio signal is available. See “Headphones” earlier in this section.

Front seat passengers can listen to playback from the A/V jacks through the vehicle speakers by selecting Rear A/V as the source on the radio.

Wired Headphone Jack

Select MENU on the remote control, then select Settings and then Wired Headphones to listen to audio on

the wired headphones. The headphone audio plays depending on which screen is selected. The default is screen 1 audio.

Remote Control

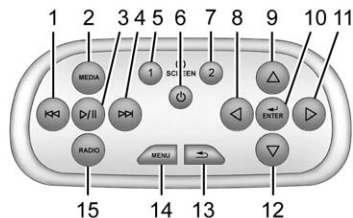

Remote Control Buttons

1. (Previous/Reverse)
 - **Radio:** Press to seek the previous radio station.
 - **CD:** Press to seek the previous track.
 - **Blu-ray/DVD:** Press to seek the previous chapter.
 - Press and hold for fast reverse.
2. **MEDIA**
 - Press to scroll through the menus including: CD, AUX, Blu-ray/DVD, SD, USB.
3. (Play/Pause)
 - Press to start playing. Press to pause. Press again to continue playing.
4. (Next/Fast Forward)
 - **Radio:** Press to seek the next radio station.
 - **CD:** Press to seek the next track.
 - **Blu-ray/DVD:** Press to seek the next chapter.
 - Press and hold to fast forward.
5. **SCREEN 1**
 - For dual seatback screens: Press to select the left screen. Once pressed, all remote control commands will only pertain to screen 1.
 - For single overhead screens:

Press to change the source displayed on the overhead screen to SCREEN 1 selected source. Select audio sources. Only one video can be played on the screen at a time. Audio for both sources will continue on the headphones. Once pressed, all remote control commands will correspond to SCREEN 1.

- For dual overhead screens: Press to select the second row overhead screen. Once pressed, all remote control commands will correspond to SCREEN 1.

6. (Power)

- Press to turn the video screens on and off.

7. SCREEN 2

- For dual seatback screens: Press to select the right screen. Once pressed, all remote control commands will only pertain to SCREEN 2.
- For single overhead screens: Press to change the source displayed on the overhead screen to SCREEN 2 selected source. Only one video can be played on the screen at a time. Audio for both sources will continue on the headphones. Once pressed, all remote control commands will correspond to SCREEN 2.
- For dual overhead screens: Press to select the optional third row overhead screen. Once pressed, all remote control commands will correspond to SCREEN 2.

- ◀ (Previous/Reverse/Decrease)
 - Radio and CD: Press to go to the previous station or track.
 - Press to go to the previous menu.
 - Press to decrease the brightness of the RSE screen.
- △ (Up Arrow)
 - Press to scroll up a list.
- ◀ /ENTER
 - Press to select the highlighted choice in any menu.
 - Press and hold for quick play.
- ▶ (Next/Forward/Increase)
 - Radio and CD: Press to go to the next station or track.
 - Press to go to the next menu.

- Press to increase the brightness of the RSE screen.
12. ▾ (Down Arrow)
- Press to go down a list.
13. ↶ (Back)
- Press to go back to the previous menu.
 - Press and hold to go back to the now playing screen.
14. MENU
- Press to go to the menu of the now playing screen.
15. RADIO
- Press to scroll through the radio sources including AM or FM.

To use the remote control, aim it at the overhead transmitter window and press the buttons firmly. Direct sunlight or very bright light could affect how the RSE receives signals from the remote control. Check the

batteries if the remote control does not seem to be working. See “Battery Replacement” following. Objects blocking the line of sight could also affect the function of the remote control.

If a CD, Blu-ray/DVD, or MP3 disc is in the CD slot, the remote control ⏻ button can be used to turn on the video screen display and start the disc. The infotainment system can also turn on the video screen display.

Caution

Storing the remote control in a hot area or in direct sunlight can damage it, and the repairs will not be covered by the warranty. Storage in extreme cold can weaken the batteries. Keep the remote control stored in a cool, dry place.

Battery Replacement

To change the remote control batteries:

1. Insert a coin or key to pull up the rear cover on the remote control.
2. Replace the two AAA batteries in the compartment.
3. Replace the battery cover.

Remove the batteries from the remote control if it will not be used for an extended period of time.

RSE Troubleshooting

No power : The ignition might not be in ON/RUN or ACC/ACCESSORY.

The picture does not fill the screen. There are black borders on the top and bottom or on both sides, or it looks stretched out : Press the MENU button on the remote control to change the display mode setting.

In auxiliary mode, the picture moves or scrolls : Check the auxiliary input connections at both devices.

The remote control does not work : Check to make sure the remote control is programmed to the correct screen. Make sure there is no obstruction between the remote control and the transmitter window and check the batteries to make sure they are not dead or installed incorrectly.

There is no sound from the headphones with the indicator light on : If the batteries are good, make sure the headphones are programmed to the correct screen and on the correct channel for the screen being viewed.

The auxiliary source is running but there is no picture or sound : Check that the RSE video screen is in the auxiliary source mode by pressing the MEDIA button on the remote control. Check the auxiliary input connections at both devices.

Sometimes the wireless headphone audio cuts out or buzzes : Check for obstructions, low batteries, reception range, and interference from cell phone towers or from cellular telephone use in the vehicle. Check that the headphones are on correctly using the L (Left) and R (Right) on the headphones. Check that the headphones are positioned properly with the headband across the top of the head.

I lost the remote and/or the headphones : See your dealer for assistance.

The Blu-ray/DVD is playing, but there is no picture or sound : Check that the RSE video screen is sourced to the Blu-ray/DVD player by pressing the MEDIA button on the remote control.

Video Display Error Messages

The video screen may display one of the following:

Disc Error : There are disc load or eject problems, the disc is inserted with the disc label wrong side up, the disc is damaged, or the disc is not from the correct region.

No Disc Inserted : No disc is present.

Disc Player Error : The temperature is outside the operating range of the RSE system. If the temperature is within range, see your dealer.

Video Distortion

Video distortion can occur when operating cellular phones, scanners, CB radios, Global Positioning Systems (GPS), two-way radios, mobile faxes, or walkie talkies.

It might be necessary to turn off the video player when operating one of these devices in or near the vehicle.

Navigation

Using the Navigation System

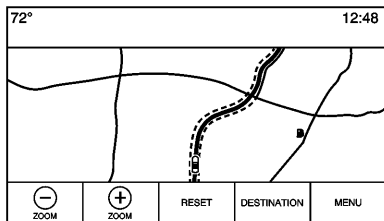

Touch the NAV button on the Home Page or the Nav icon in the applications tray to access the navigation application.

Touch MENU from the map view to access the Navigation Menu. Features displayed in the Navigation Menu can be selected to adjust navigation preferences.

It is advised to set up preferences before setting a destination. To set a destination, see *Destination* ⇨ 62.

The buttons on the infotainment screen display will time out when not interacting. Tap anywhere on the screen to reveal the controls, then select the desired control.

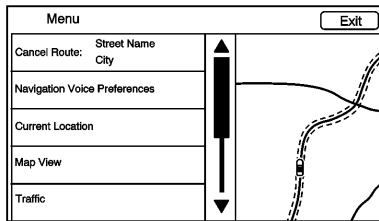

Additional navigation features are:

- Cancel Route/Resume To
- Navigation Voice Preferences
- Current Location
- Map View
- Traffic
- Display “Places of Interest” Icons
- Routing Preferences
- Personal Data

Cancel/Resume Route

- While under route guidance, this screen button displays Cancel Route. Touch Cancel Route to cancel route guidance. No further prompts will be given. The list item then changes to Resume To.
- Touch the Resume To screen button to resume route guidance to the last entered destination.
- The last location that the system has provided guidance to can be resumed by touching on this list item.
- If the route includes waypoints, the entire route can be suspended using the Cancel Guidance list item. When Resume Guidance is touched, all waypoints are resumed for guidance.

Navigation Voice Preferences

Touch the Navigation Voice Preferences list item to adjust the voice preferences.

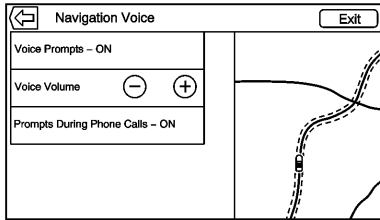

The following options can be adjusted:

- Voice Prompts ON-OFF
- Voice Volume
- Prompts During Phone Calls ON-OFF

Voice Prompts

Touch the Voice Prompts list item to toggle voice prompts ON and OFF.

Voice Volume

Adjust the loudness of the audio feedback by touching the - or + button. If a maneuver prompt is being played, and the main volume is adjusted, the prompt volume will update and be saved.

Prompts During Phone Calls

When enabled, the system plays a shorter prompt while on a phone call. This setting can be configured as to whether a prompt would be heard during a phone conversation.

When this setting is OFF, only the short alert tone is played when approaching the maneuver.

Current Location

Touch the Current Location list item to display a Current Location list.

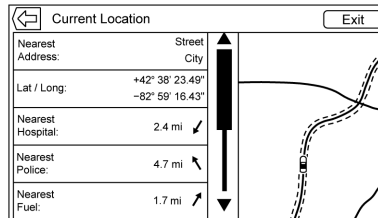

The following information is displayed on the Current Location list:

- Nearest Address
- Lat/Long

- Nearest Hospital
- Nearest Police
- Nearest Fuel
- Nearest Service

Touch on any of the options to display the destination details view for the selected location to begin guidance.

Touch the Nearest Address button and then the Save screen button to store the current location to the Address Book.

Map View

Touch to select the desired map view. A checkmark appears to indicate a view has been selected.

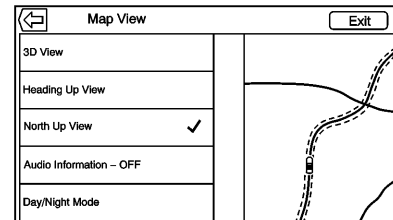

3D View

The 3D View is a Heading Up view but it includes perspective. Map items will appear larger as the vehicle comes closer.

Heading Up View

The Heading Up View keeps the vehicle's current heading at the top of the view. The vehicle icon always faces the top of the view as the map rotates.

North Up View

The North Up View keeps north at the top of the view. The vehicle icon is placed in the center of the view and rotates to indicate the heading for the vehicle.

Audio Information On/Off

Touch to turn the audio information view on or off from the main map view.

The audio status screen contains the following elements:

- Station Frequency
- Artist Information
- Song Information

- ▶ / || or ◀ / ▶ Station and Channel Controls

Touch the ◀ / ▶ Station controls to go to the next or previous strong signal station or digital channel.

When the audio status pane displays Artist and Song Information, touch the ◀ / ▶ controls to go to the next or previous track based on the current media mode.

Day/Night Mode

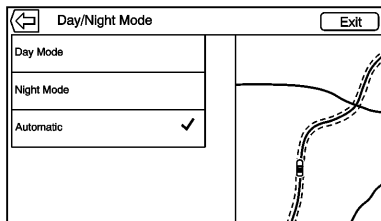

Touch to access the Day/Night Mode menu.

The options are:

- Day Mode: Brightens the map background.

- Night Mode: Darkens the map background.
- Automatic: Adjusts the screen background automatically depending on the exterior lighting conditions.

Traffic (If Equipped)

Touch to browse the traffic in the area as well as adjust the traffic settings. Where traffic information is available, it is displayed on the map.

Where live traffic flow data is available, it is displayed as a solid line adjacent to the road. The road is displayed in colors to show the flow rate as:

- Black – Stopped or Closed
- Red – Poor
- Yellow – Slow
- Green – Normal

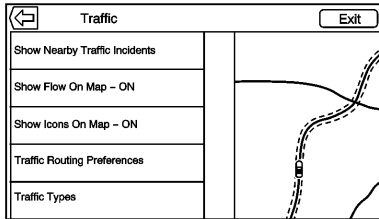

There are several options on the Traffic menu:

- Show Nearby Traffic Incidents
- Show Flow On Map ON-OFF
- Show Icons On Map ON-OFF
- Traffic Routing Preferences
- Traffic Types

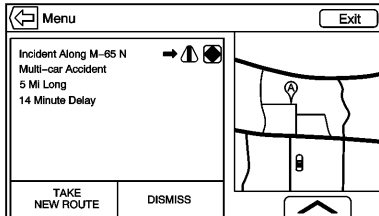

1. Touch Show Nearby Traffic Incidents to access the Traffic List menu. This menu displays the incident symbol and highway name, along with the distance and heading to the incident.
2. Touch on the incident to display additional details about the incident as well as an option to avoid that particular incident if it is along the current route.

Traffic Routing Preferences

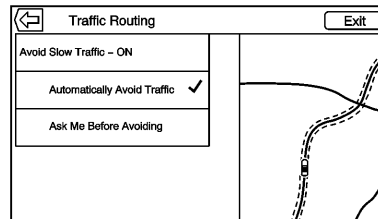

The system can be configured as to how it reacts when receiving traffic information. Touch Traffic Routing Preferences to access the Traffic Routing menu.

When this setting is OFF, the system will never take traffic conditions into account when creating routes. In addition, the two options below are grayed out. If one of the grayed-out options is touched, it automatically turns the traffic avoidance feature ON and performs the desired selection.

The two options, Ask Me Before Avoiding and Automatically Avoid Traffic will adjust the system as follows:

- If the Automatically Avoid Traffic list item is touched, the system will automatically adjust the route based on traffic without notifying the driver.
- If the Ask Me Before Avoiding list item is touched, the system will always use Alerts to show when there is an incident and allow it to be avoided by touching the avoid button.

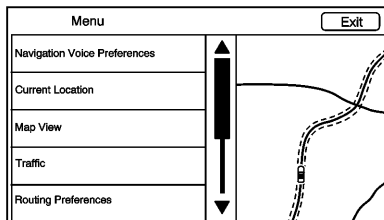

If the Traffic list item is touched from the Map Menu and Traffic is not available because the SiriusXM subscription is not valid, a pop-up will display with information on how to reactivate the subscription along with the SiriusXM radio ID.

Traffic Types

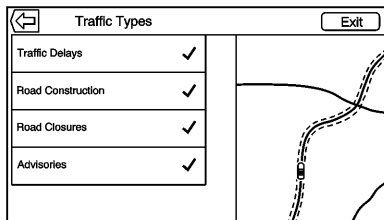

Touch to access the Traffic Types menu.

The system can be configured to filter out certain types of traffic events. If a particular type has been turned off, the system does not display it on the map, and does not alert the driver.

Display Places of Interest Icons

Places of Interest (POI) icons can be displayed on the map using this view.

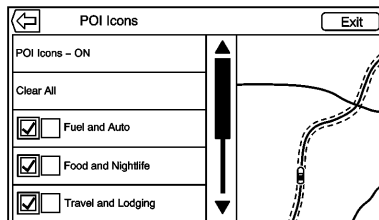

- The POI icons can be turned ON and OFF. Touch the check box next to the POI icon to display the icon.
- Touch Clear All to reset the icons that are displayed on the map.

- A subcategory can be selected instead of the entire category. Touch the list item rather than the check box. The subcategories will display. Select any of those categories to navigate down the hierarchy.
- When a higher-level category has some of its subcategories selected, the checkmark next to it is grayed out. This indicates that only some of the categories below are shown. Touch the grayed-out checkmark to turn all of the icons for that category on or off.

Routing Preferences

Touch the Routing Preferences list item to access the Routing Preferences menu. Options on how the routes are created for route guidance are listed on this menu.

Route Style

Touch this list item to change the route type preferences.

The options are:

- Fast (default)

- Eco Friendly (if equipped)
- Short
- Edit Eco Profile

The Edit Eco Profile can be used to configure two parameters for the Eco Friendly route. These parameters are roof load and trailer. For each parameter, the options are None, Small, Medium, and Large. Press to scroll through the list. The default for both is None.

These preferences are used for all routes generated.

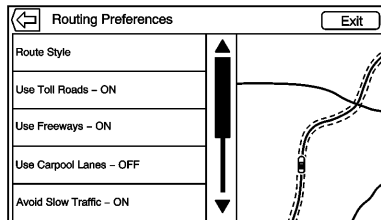

Route segment preferences are other options showing on the Routing Preferences menu.

This includes:

- Use Toll Roads ON-OFF

- Use Freeways ON-OFF
- Use Carpool Lanes ON-OFF
- Avoid Slow Traffic ON-OFF
- Use Tunnels ON-OFF
- Use Time Restricted Roads ON-OFF

Personal Data

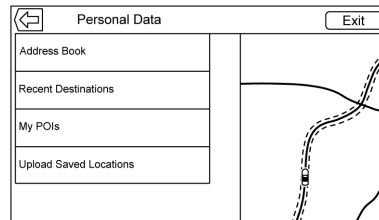

Data that the system has saved during the course of using the navigation system can be managed through:

- Address Book
- Recent Destinations
- My POIs (if equipped)
- Upload Saved Locations

Address Book

1. Touch Edit Address Book to display the Address Book to edit.
2. Touch Delete All Entries to delete the entire list of contacts. A pop-up displays to confirm.

Recent Destinations

- Touch Delete Individual Destinations to display a recent destinations list. Select the individual entry to delete.
- Touch Delete All Destinations to delete the entire recent destination list. A pop-up displays asking to confirm the deletion.

My POIs

- Touch My POIs to display a menu of other options.
- Select Delete Individual Categories. A My POIs category list displays.
- Select the individual entry to delete.

- Touch Delete All My POIs to delete the entire list of categories. A pop-up displays asking to confirm the deletion.
- To exit out of a list, touch the Exit screen button in the top right corner of the map to return to the main map view.

Upload Saved Locations: Touch to upload any saved locations such as downloaded POIs and all entries in the vehicle address book to the USB device.

- Touch Upload Saved Locations to save the Vehicle Contacts list and any My POIs that have been saved to the vehicle.
- Once saved locations have been uploaded to a USB, they can be transferred to a different vehicle or restored to the current address book.

Map Adjustments

ZOOM +/- can be used to adjust the scale of view on the map. When the end of the zoom level is reached, ZOOM +/- will gray out.

The zoom scales can be configured for English or metric units. To change from English to metric, see “Instrument Cluster” in the owner manual.

Scroll Features

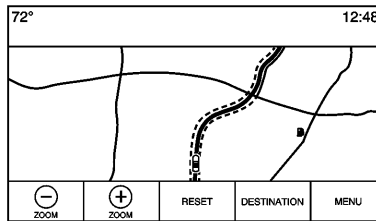

- To scroll within the map, touch anywhere on the map screen.
- Nudge or slide a finger on the map; the map moves in the direction of the finger.
- Fling a finger on the map; the map will start scrolling in a short continuous scroll.
- Touch a finger on the location on the map; the map recenters to the location that was touched on.

- Touch a finger twice on a location on the map; the map zooms in one level to the location that was touched twice on.
- When the map is recentered away from being locked to the vehicle position, the crosshairs will show in the center of the map. As the map continues to be recentered, the crosshairs will remain on the screen. When the crosshairs are shown on the screen, a callout with more information displays. If the map is moved from the current location, the crosshairs will disappear along with the callout.
- Touch a finger on the callout next to the crosshairs and the destination details view displays. From this view, route guidance can be received or saved to the vehicle's contact list.
- When the map is recentered, the straight-line distance from the vehicle to the selected point is displayed in the callout. In addition, a heading direction in

the form of an arrow is displayed to indicate the direction. The arrow is shown in relation to the current vehicle heading.

- Touch a finger on a POI icon shown on the map; the name of the POI is shown in the address callout, along with the city name and state. If the callout is selected, the destination details view for the POI is shown.
- After panning the map away from the vehicle, touch RESET to return the map back to the current position.
- Touch the Overview button to quickly get a view of the entire route. The route Overview button takes the place of the RESET button while under route guidance. Touch the RESET button to return the map to the current position.

Maps

The map database is stored in the internal flash memory that is used in the navigation system.

Detailed Areas

Road network attributes are contained in the map database for detailed areas. Attributes include information such as street names, street addresses, and turn restrictions. A detailed area includes all major highways, service roads, and residential roads. The detailed areas include Places of Interest (POIs) such as restaurants, airports, banks, hospitals, police stations, gas stations, tourist attractions, and historical monuments. The map database may not include data for newly constructed areas or map database corrections that are completed after production. The navigation system provides full route guidance in the detailed map areas.

Navigation Symbols

Following are the most common symbols that appear on a map screen.

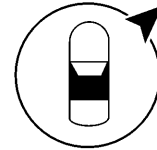

or



The vehicle symbol indicates the current position and heading direction of the vehicle on the map. When under route guidance, a circle with an arrow is added to the vehicle symbol which indicates the direction to the destination.

Vehicle Address Callout

Tap on the vehicle icon, to have the current address of the vehicle overlaid on the map next to the vehicle icon in a callout. Another tap hides the information.

Any address information about the vehicle's current location will be shown, including the street, city, and state names.

Tap on this callout to save the current address to the vehicle address book.

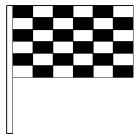

The destination symbol marks the final destination after a route has been planned.

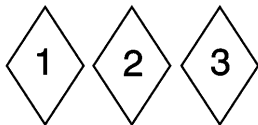

The waypoint symbol marks one or more set waypoints.

A waypoint is a stopover destination point added to the planned route.

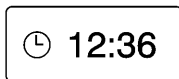

The estimated time to the destination displays. Touch the Arrival button to toggle to duration and to the distance of the destination.



This symbol indicates the recommended maneuver that should be performed. Touch it to display the turn list or waypoint list.



The No GPS symbol appears when there is no Global Positioning System (GPS) satellite signal. When the GPS is gone, the vehicle position on the map may not be accurate.

Autozoom

As a maneuver is being approached, the map automatically zooms in to give greater detail.

If lane guidance is available for the maneuver, this is also shown.

When the system begins to autozoom, it zooms in to its minimum level. After the maneuver is performed, the system slowly zooms back out.

Destination

If route guidance is not active, touch the NAV screen button on the Home Page to access the map view.

Touch the Destination icon from the map view to enter a destination.

Available methods of entering a destination are Voice Recognition, Address, Recent Destinations, Contacts, and POIs. Several options

can be selected to plan a route. Some destination items may be grayed out if no destination was previously entered or saved.

Another way to enter a destination is to connect to the OnStar[®] system (if equipped) and ask an OnStar Advisor to download a destination into the embedded navigation system. See *OnStar[®] System* ⇨ 75.

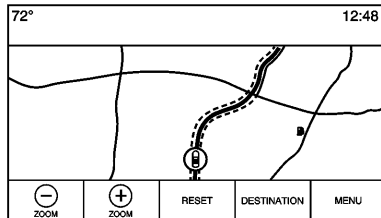

Touch the DESTINATION button to go to the destination entry views.

Available Methods of Search

- Voice Recognition
- Address
- Recent Destinations
- Contacts

- POIs

Touch the DESTINATION button and the last used destination view is shown.

Navigation Next Turn Maneuver Alert

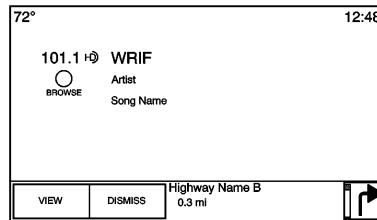

The navigation system has an alert feature. The navigation system may need to get the attention of the driver.

If not in the navigation application when a near maneuver prompt is given, it is shown as an alert. The alert contains the turn indicator and button to display the main navigation view, or dismiss the alert.

The alert also contains the name of the street to turn on and a countdown bar.

Alpha-Numeric Keyboard

The keyboard is used in multiple locations throughout the system and can be used with many features. The navigation system uses the keyboard's alpha-numeric keyboard.

The keyboard can also be modified to include characters appropriate for the region configured in the vehicle settings.

✓ **GO** : Touch to search for the destination details of an address or place of interest entered in the text field. Once the GO screen button is pressed, the activity indicator displays in the list of possible matches.

▽ (**Dropdown Arrow**) : Touch to display a list of matches.

When there are multiple matches, a dropdown arrow is shown after the autocomplete text. This dropdown displays an entire list of matches. Touch the appropriate match without having to enter more text.

X (**Delete**) : Touch to delete the last typed character. Press and hold this screen button to clear the entire text

field. If the entire text field has been deleted, this screen button becomes an Undo button. Touching Undo will restore the deleted text.

Exit : Touch to return to the previous Map view.

Sym : Touch to show the symbol keyboard.

Space : Touch to enter a space between characters or the words of a name.

 (**Up Arrow**) : Touch to display the Interaction Selector.

Special Characters

As the characters are typed on the keyboard, a pop-up of the letter touched displays above the key that was touched.

Continue to touch and hold, and any additional special characters associated with that letter are displayed around the current letter. To select one of the special characters, slide a finger left or right to adjust the highlight of the special character.

Special Character List

The following characters have special characters beneath them:

E - É Ê Ë Ì Í Î Ï	More Characters:
Y - Ÿ	0 - °
U - Ů Ú Ū Ŭ Ů	! - ¡
I - Ī Ĭ Ī Ī Ī	\$ - ¥ £ ¢
O - Ŏ Ø œ Œ Ő ő Õ õ	& - §
A - Å Ä Å Å Å Å Å	" - «»
S - ß (for lowercase s) Š š	? - ¿
L - Ł	{ - {
Z - Ź Ź Ź	} - }
C - Ć Ć Ć	.com -.net .org
N - Ń Ń	
- - ...	

Creating and Downloading Predefined POIs (My POIs)

In addition to the POIs already stored in the Infotainment system, predefined POIs can be created.

While creating a predefined POI, the GPS coordinates for longitude and latitude of the POI's location and a descriptive name will need to be entered.

After creating the predefined POIs, they can be downloaded to the infotainment system from either a USB stick or SD card.

Once downloaded, the POI data becomes a selectable destination in the My POIs menu.

Creating a Text File with Information

Create a text file by using a simple text editor software. Save this file with a name and extension of .csv, for example, "TomsPOI.csv."

Enter the POI information into the text file in the following format:

- Longitude coordinate, Latitude coordinate, "Name of POI," "Additional information," "Phone number."

Example: 7.0350000,
50.6318040, "Michaels Home,"
"123 Maple Lane,"
"02379234567."

- The GPS coordinates must be expressed in decimal degrees and can be taken from a geographical map. The additional information and phone number strings are optional.

- The POI name and the additional information string may not exceed 60 characters.
- POI information for each destination address must be entered in a single separate line.

Storing the POI on a USB Drive

In the root directory of a USB drive, create a folder name “myPOIs.” For example, “F:\” is the root directory of the USB drive.

In the “myPOIs” folder, store the text file with your POIs, for example, “F:\myPOIs\TomsPOIs.csv.”

Downloading the POI to the Infotainment System

Connect the USB drive or SD card containing the POI information to the USB port or SD card slot of the infotainment system. A message displays prompting whether or not to download the POI information from the USB stick. All POIs found are saved even if they are in multiple folders.

Subfolders can also be created to organize the POIs into categories, for example, “F:\myPOIs\Restaurants\TomsPOIs.csv.”

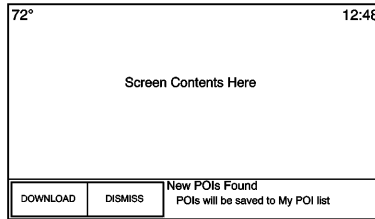

If the message is dismissed or ignored, no POI information is downloaded. This prompt will not reoccur for the current ignition cycle.

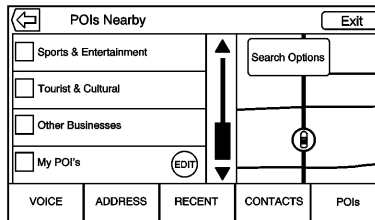

When the system is finished downloading, a pop-up displays asking to specify a category for the new POIs, if desired.

Importing and Overwriting Categories

When POIs are found on a media device, the date of the file is examined and compared to the date for the files already in the system. If the file being downloaded is newer than the one on the system, that particular category of POIs is overwritten. Any other POIs that had previously been saved in other categories are not affected.

Address Book Download

If an Address Book is found on the connected USB device, the same alert is used to indicate that locations have been found and they can be downloaded. If there is already content in the vehicle Address Book, the system prompts if the stored content should be overwritten. Select Save to overwrite the existing Address Book information. Select Cancel to abort the import of information.

Browsing Downloaded POIs

Access the downloaded POIs by selecting the My POIs list item in the POIs list.

Edit My POIs

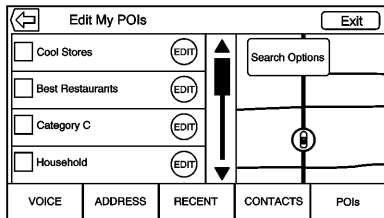

Downloaded POIs can be edited at a category level. These POIs can either be deleted as an entire category or reassigned as another category. To edit the categories:

- Select the Edit button at the main category view to edit the POIs. Edit buttons display next to each category name. There is no POI browsing in this mode; only edit functions are available.

- Once an action such as deleting or reassigning has been selected, the changes are saved immediately.

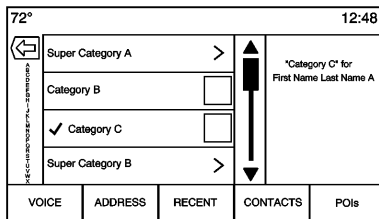

Changing POI Categories

POI categories can be assigned to a different category by using the same method as assigning a category for an Address Book entry. When editing, the right side of the screen displays the current category name.

Deleting POI

POI categories can be deleted by selecting Edit and then Delete. A pop-up displays to confirm the deletion.

Saved Destinations

Select a saved destination from the Contacts or Recent Destinations.

Contacts

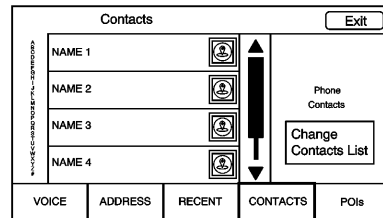

Select the CONTACTS button to view the vehicle's contact list or a connected Bluetooth device. If a particular contact has a single address associated with it, that contact has a Quick Route list item function button next to it. Contacts without this Quick Route button either have multiple addresses or no address at all. Touch the Quick Route button to go to the Destination Details view.

Touch on an address, either from the Quick Route on the contact list or a specific address from the

contact detail list, to go to the destination view showing that address on the map.

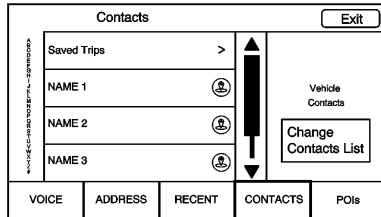

Trips from Contacts can be saved and recalled. The order is based on when the trip was last used. When the trips are saved, they are given a default title of the final destination name. If there are no saved trips, this list item is hidden.

Favorite Destinations

- Destinations can be saved as Favorites for recall later. Depending on the favorite, when an address or POI favorite is recalled, the Destination Details View is shown.
- When a favorite address is being routed to, it is shown active. Touch on the active favorite to suspend that route.
- Save locations as Favorites for recall later in the Destination Details View.
- Save trips from the Address Book.

Storing Favorites from the Contact Details List

A contact name or any of the contact's information such as phone number, e-mail address, or address from Contact Details can be stored as a Favorite.

- Touch and drag up on the row of Interaction Selector buttons to reveal the Favorite buttons.
- Touch and hold on the favorite location while viewing a contact on the Contact Details List. The contact name and all contact information can be stored.
- Touch to save as a favorite. The favorite label will be the name of the contact.

- Touch on the Favorite to display the destination view.

Storing Favorites from Map

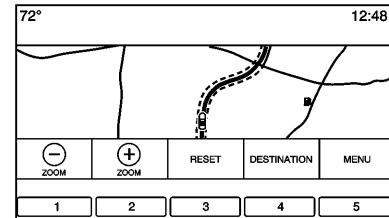

Favorite locations can be stored from the Map View.

If not under route guidance, the current vehicle location will be saved as a Favorite. If under route guidance, the final destination will be saved.

Touch and drag up on the row of Interaction Selector buttons to reveal the Favorite buttons. Touch and hold on the favorite location from the Map View to save it.

Route Guidance

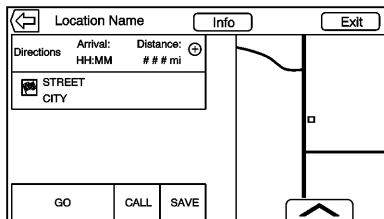

- Touch GO to go to the main navigation view and to start route guidance.
- If the system has an active route, a pop-up will display, “What would you like to do with this destination?” The options are: Add As Waypoint, Set New Destination, or Cancel.
- If a waypoint is added, it is placed in the location that leads to the most efficient route.
- There is a maximum number of waypoints that can be added to the system. When the maximum number of waypoints has been reached, a pop-up displays indicating that a waypoint must

first be deleted before a new one can be added. The system will hold this waypoint into a Pending Waypoints list and will automatically be added to the route once a position is available, either by arriving at a waypoint, or by deleting one.

- To save a location, tap on the ▲ to display the Favorite buttons. Touch and hold on a favorite location to save the shown location as a Favorite.

Estimated Time of Arrival (ETA) and Distance

- When under route guidance, the system shows the ETA or travel time, or the driving distance.
- The ETA and travel time are calculated using any available traffic information.
- If in a waypoint trip, the ETA, travel time, and driving distance are all shown relative to the final destination.

- The final ETA is shown taking into consideration any time zone crossings that the route has traveled through.
- Touch the ETA information area to switch between the estimated arrival time, total driving time resulting, and driving distance.

Turn List

Touch on the next turn indicator shown on the map to display the turn list or waypoint list. The Interaction Selector is minimized automatically. Touch ▲ to reveal the following options:

Destination

Touch the DESTINATION screen button to add a waypoint or change the destination while viewing the turn list. When the DESTINATION screen button is touched, the display shows the Destination screens.

End Guidance

Touch the End screen button to suspend the current route in the turn list. When the End screen button is

touched, the turn list is exited, and the display returns to the main map view.

Avoid Areas

Touch the Avoid Areas screen button to select the highway name that is to be avoided. The system shows a pop-up asking how many miles or if the entire road should be avoided.

Turn List

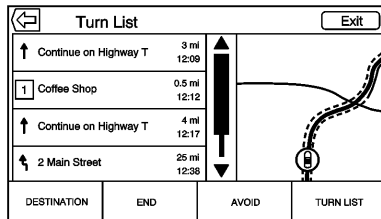

- When under a waypoint trip, touch on the TURN LIST Interaction Selector button to show the turn list. When entering a turn list, the next maneuver instruction is spoken.

- The turn list title is the name or address of the destination. Touch on the information button next to the name of the destination to display the destination information.
- The turn list is sorted in order with the next maneuver at the top of the list and the subsequent maneuvers listed below it. The next maneuver is always highlighted upon entry into the Turn List to quickly show what the next maneuver is.
- Each maneuver indicates the distance between it and the previous maneuver or the vehicle's current location. The next maneuver at the top will count down until the maneuver is reached, and then the next maneuver will begin to count down.
- Each maneuver has an estimated time of arrival based on the current driving conditions.

Saved Trips

Waypoint trips can be saved for later recall. Touch the + add button in the waypoints list to save the trip to the Saved Trips list in the vehicle's contacts list. When trips are saved, they are given a default title of the final destination. Saved trips can be edited by selecting the Edit list item button to access the edit screen for the saved entry. The only field that can be edited is the name field. Touch on the name field to access the keyboard view. Type the name change. This change is automatically saved when executed by the keyboard.

The saved trip can also be deleted from the edit mode. Touch the delete button and a delete confirmation pop-up will display.

Waypoints

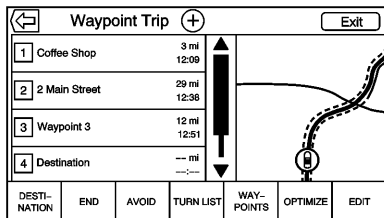

- When under a waypoint trip, touch on the next turn indicator to bring up the waypoint list. The last waypoint view is shown, which could be Waypoints, Turn List, or Edit.
- The waypoint list is sorted in order with the next waypoint at the top of the list. Each waypoint is indicated with a numbered icon, starting with the next waypoint.
- To indicate what segment of the route is for the next waypoint, and what is for the remainder of the route, they appear in different colors.

Optimized Route

- Touch the OPTIMIZE screen button to optimize the current waypoint trip.
- The optimization is done according to how the preferences are set for new routes, e.g., fastest route, shortest distance, or eco friendly.
- While the system is optimizing the route, the waypoint trip has the Activity Indicator displayed over top of it. If the system is calculating the ETA and travel distance for a waypoint, the Activity Indicator is displayed in the list header.
- When either a waypoint trip is first created, or additional waypoints are added to an existing waypoint trip, they are added in the location that would lead to an optimized route.
- If a destination is already planned and a waypoint is added, it is either added before

or after the current destination, whichever leads to the most optimal route.

- If under an existing waypoint trip consisting of two or more destinations, any additional waypoints are added in the location that would lead to the most optimal route.

Edit Route

- Touch the EDIT screen button to modify the order or remove a waypoint from the route. Press the delete screen button to remove a waypoint from the route.
- A pop-up displays asking for confirmation of the waypoint deletion.

SiriusXM Travel Link Weather (If Equipped)

SiriusXM Travel Link Weather is available on the navigation system through a service fee subscription.

From the Home Page, touch Weather. The system displays the current weather page.

Current Condition

The current weather page displays:

- Doppler Map with Weather
- Forecast Information
- Interaction Selector
- Status
- Time of Map Update
- Applications Tray

Allow approximately 15 minutes for the current weather in the area to display.

Weather Regions

When in the weather application, touch the SEARCH icon to display a split map. The list displayed on the left of the split map allows changes to the location.

The Doppler map and forecast information display a preview of the map for the location selected. The forecast information is for the current weather or next available forecast data.

Touch the EXIT screen button to return to the main weather map.

Touch one of the options displayed on the Interaction Selector along the bottom of the map screen to select another function or display another type of list.

Weather Screen Not Under Guidance

The weather application uses the navigation system to provide the appropriate information for the guidance route. When not under guidance, it defaults to the current location.

Doppler Map : The Doppler map is shown with the vehicle location in the center of the map.

City and State : The city and state are displayed for the view currently shown. The default is the current city and state that the vehicle is in.

Forecast Information

- The map can be panned to another location. The forecast information is updated to the new location.
- The city and state update to reflect the current location.

- Touch the RESET screen button to reset the map back to the current vehicle location.

Weather Menu

Touch MENU on the Weather Interaction Selector along the bottom of the map screen to display the Weather Menu.

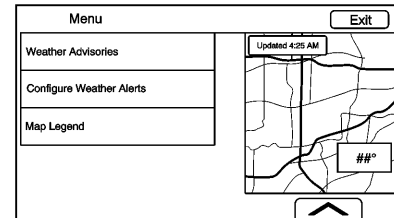

The options are:

- **Weather Advisories:** Any weather advisories that are in effect for the local area or while on route are displayed in a list. Touch on an advisory from the list to display a screen that gives additional details about the advisory and shows the advisory location on the map.

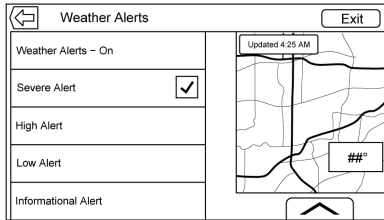

- **Configure Weather Alerts:** Touch to access the Weather Alerts menu. Touch the Weather Alerts line item to turn the alerts On or Off. Touch to select any one of the other line items such as High Alert, Low Alert, Informational Alert to filter the selected alerts for display, while the others will be suppressed.
- **Map Legend:** Touch to display the Map Legend.

Interaction Selector

The Interaction Selector at the bottom of the screen can be used to switch between different views within the weather screen.

These buttons are:

- **ZOOM – or ZOOM +:** Touch to zoom the map in or out.
- **RESET:** Touch to reset the map back to its original location.
- **SEARCH:** Touch to search for a new weather map location. The last destination screen displays. Touch any button along the bottom of the Interaction Selector to help find a different destination. These are , CITIES, and RECENT.

Touch RECENT to display a list of recent locations that were recently viewed for weather.

Touch  to activate voice recognition. Say a city and state or ZIP code. Follow the voice prompts to find weather for a desired location.

Touch CITIES to enter a city and state or ZIP code.

Type a city or state name on the keyboard screen to find the weather. If the state is omitted, the system assumes a city is

being searched for within the current state. If the ZIP code is typed, the system displays the city associated with that ZIP code.

- If one match results from a weather search, the system returns to the map. The map and forecast information updates for that location.
- If there are multiple results from the weather search, a list of possible matches displays. The map shows the first match in the list along with the current weather information in the lower right corner.
- **HOURLY:** Touch to display the hourly forecast for the current vehicle location. A forecast icon is shown for each period available.
- **36-HOUR:** Touch to display the current weather, six-hour forecast, and tomorrow's weather. A forecast icon is shown for each period available.

- **DAILY:** Touch to display a daily forecast for the next five days. A forecast icon is shown for each period available.
- **MENU:** Touch to display the current advisories, turn weather alerts on or off, and view the map legend.
- **ON ROUTE:** Touch to display the forecasted weather for the route. This feature is only available while under route guidance.

The map legend explains each type of color or symbol on the map.

SiriusXM NavTraffic (If Equipped)

The infotainment system may have SiriusXM NavTraffic®. It is a subscription service provided through SiriusXM Satellite Radio. A service fee is required to receive the SiriusXM NavTraffic service.

Detailed traffic information is delivered to the vehicle's navigation system by the SiriusXM Radio

satellites. SiriusXM NavTraffic provides continuously updated traffic information.

The service may be available in more cities in the future. Visit www.siriusxm.com/navtraffic for more details on local coverage.

To access the traffic features, touch the Traffic screen button on the Map Menu.

If traffic is not available because there is no valid SiriusXM subscription, a pop-up displays information on how to reactivate the subscription and SiriusXM radio ID.

Traffic Alert While Under Guidance

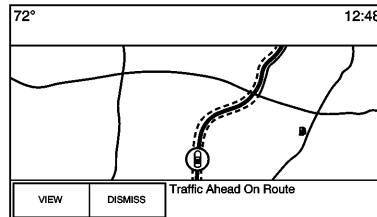

If data is received about a traffic development on the route ahead, a search for a better route is

performed. If a better route is found, information may be displayed in an alert. This alert displays the route information and how much time may be saved. If the alternative route is accepted, the current route will be altered.

If the alert is not acknowledged, the alert automatically times out and does not modify the route.

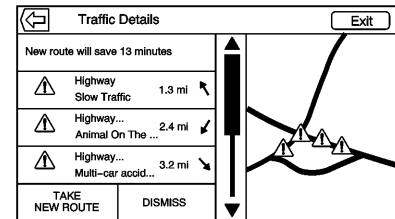

The detail view of the incident shows any data about the incident as well as how much time could be saved by avoiding it. The map view shows the incident, the original route, and the suggested route. If voice prompts are enabled, the incident information is spoken.

Touch the TAKE NEW ROUTE screen button to change to the new route.

Traffic Alert While Not Under Guidance

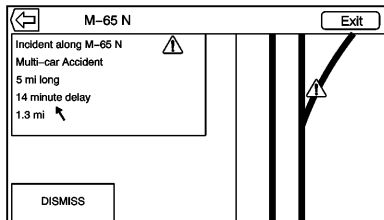

While driving and not under guidance, the system can receive data indicating an accident or slow traffic flow. The information about the incident or slow traffic is displayed as an alert when the incident is 5 km (3 mi) ahead. The incident can be viewed on the map. Touch the DISMISS screen button to return to the previous map.

SiriusXM Travel Link Movie Listings

A movie theater POI can be searched through a POI search or browsed through the POI category structure. When SiriusXM Travel Link Movie Listings information is available for the selected theater, this detailed information is shown in the additional details area of the display.

The details that are shown depend on the source of the information.

Details shown include:

- Movie Names
- Parental Ratings (G, PG-13, R, etc.)
- Showtimes
- Runtime

SiriusXM Travel Link Fuel Pricing

When SiriusXM Travel Link Fuel Pricing information is available for a particular fuel station, the price

displays for the regular unleaded or diesel fuel, depending on the fuel type configured in the system.

This fuel station POI can either be searched for through a POI search or browsed through the POI category structure.

- Touch the Sort button to change the sort method. The default sort method is based on distance with the closest fuel stations shown at the top of the list.
- Touch the Sort button to cycle through the sorting options of distance, price, or name. The last viewed sorting method is displayed and is retained over ignition cycles.

If the sorting method of price has been selected, the fuel stations in the list will appear from the lowest to the highest price based on the fuel type selected. For gasoline, the price shown is for regular unleaded. When diesel is selected as the fuel type, the diesel price is shown.

OnStar® System

With an OnStar® subscription, an OnStar Advisor can download a destination to the vehicle or into the built-in navigation system. If an OnStar Turn-by-Turn route is in progress, all other internal navigation functions are disabled until the route is completed.

When navigation is selected, the OnStar Turn-by-Turn screens display.

Turn-by-Turn Navigation

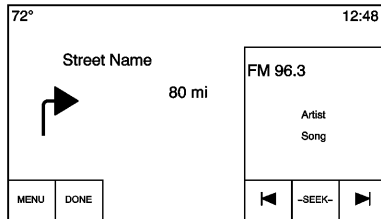

Touch the MENU button to go to the Turn-by-Turn Menu.

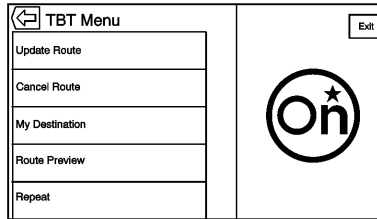

The following options display:

- Update Route (if the vehicle is off the route)
- Cancel Route
- My Destination
- Route Preview
- Repeat

My Destination

Select My Destination to display, a special version of the Maneuver View. The Destination Address is displayed in the Street Name and the total distance to the destination is displayed in the Distance to Maneuver View. Touch the DONE button to return to the Maneuver View.

Route Preview

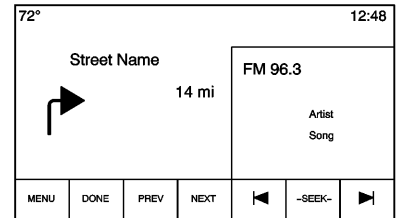

- Touch Route Preview to display the Maneuver View.
- Touch NEXT or PREVIOUS to display the next or previous maneuver information, including distance between it and the previous maneuver.
- Touch the DONE button to return to the Maneuver View.

Repeat

Select Repeat to go back to the Maneuver View and repeat the audible maneuver prompt.

No Active Route



There is no active route if:

- The vehicle does not have a built-in navigation system and the navigation application is selected from the Home screen.
- If the system receives the indication that there is an active OnStar subscription, the help text is displayed with instructions on how to set up a route.

Cancel a Route

If a route is in progress using either the vehicle navigation system or the OnStar Turn-by-Turn route, and a new route is requested, the current route in progress will be canceled.

An OnStar Advisor can cancel the vehicle navigation system route. Route guidance can be resumed by selecting the Resume To screen button in the Map Menu.

Settings

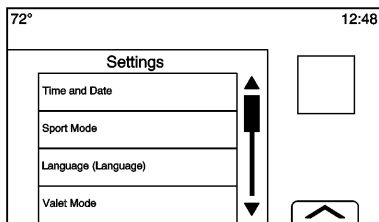

Touch Settings on the Home Page to adjust features and preferences, such as Time and Date, Sport Mode, Language, Valet Mode, or Radio. For setting options, see *Settings* ⇨ 95.

A few of the setting options change the way the navigation system displays or reacts while in use.

1. Touch the Settings screen button on the Home Page.

2. Touch the scroll bar until the desired option displays. Select the desired settings to change.

Voice

Voice recognition allows for hands-free operation within the navigation, audio, phone, and weather applications. See *Voice Recognition* ⇨ 80.

Touch the voice screen button to display the Voice menu.

Prompt Length : Touch to change the prompt length to Short or Long.

Audio Feedback Speed : Touch to change the audio feedback speed to Slow, Medium, or Fast.

Display

Mode : Touch Mode to change the screen background. This setting controls map colors.

- The Auto setting adjusts the screen background automatically depending on the exterior lighting conditions.
- The Day setting brightens the map background.

- The Night setting darkens the map background.

Calibrate Touchscreen : Touch to display the Touchscreen Calibration Screen.

Turn Display Off : Touch to turn the Display option off.

Low Fuel Alert

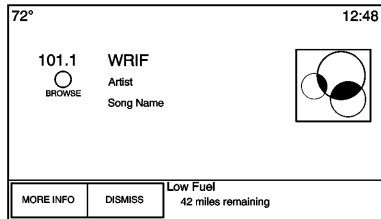

If the vehicle reaches a low fuel level, the system displays an alert about the low fuel condition. Touch the MORE INFO screen button to view nearby gas stations, and start guidance if desired.

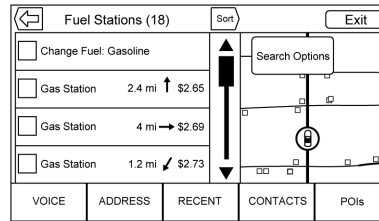

If the remaining driving distance is available from the system, this is included in the alert.

Global Positioning System (GPS)

The position of the vehicle is determined by using satellite signals, various vehicle signals, and map data.

At times, other interference such as the satellite condition, road configuration, condition of the vehicle, and/or other circumstances can affect the navigation system's ability to determine the accurate position of the vehicle.

The GPS shows the current position of the vehicle using signals sent by GPS satellites. When the vehicle is

not receiving signals from the satellites, a symbol appears on the map screen. See *Navigation Symbols* ⇨ 61.

This system might not be available or interference can occur if any of the following are true:

- Signals are obstructed by tall buildings, trees, large trucks, or a tunnel.
- Satellites are being repaired or improved.

For more information if the GPS is not functioning properly, see *Problems with Route Guidance* ⇨ 78 and *If the System Needs Service* ⇨ 79.

Vehicle Positioning

At times, the position of the vehicle on the map could be inaccurate due to one or more of the following reasons:

- The road system has changed.
- The vehicle is driving on slippery road surfaces such as sand, gravel, or snow.

- The vehicle is traveling on winding roads or long straight roads.
- The vehicle is approaching a tall building or a large vehicle.
- The surface streets run parallel to a freeway.
- The vehicle has been transferred by a vehicle carrier or a ferry.
- The current position calibration is set incorrectly.
- The vehicle is traveling at high speed.
- The vehicle changes directions more than once, or the vehicle is turning on a turn table in a parking lot.
- The vehicle is entering and/or exiting a parking lot, garage, or a lot with a roof.
- The GPS signal is not received.
- A roof carrier is installed on the vehicle.
- Tire chains have been installed.
- The tires are replaced or worn.

- The tire pressure for the tires is incorrect.
- This is the first navigation use after the map data is updated.
- The 12-volt battery is disconnected for several days.
- The vehicle is driving in heavy traffic where driving is at low speeds, and the vehicle is stopped and started repeatedly.

Problems with Route Guidance

Inappropriate route guidance can occur under one or more of the following conditions:

- The turn was not made on the road indicated.
- Route guidance might not be available when using automatic rerouting for the next right or left turn.
- The route might not be changed when using automatic rerouting.
- There is no route guidance when turning at an intersection.

- Plural names of places might be announced occasionally.
- It could take a long time to operate automatic rerouting during high-speed driving.
- Automatic rerouting might display a route returning to the set waypoint if heading for a destination without passing through a set waypoint.
- The route prohibits the entry of a vehicle due to a regulation by time or season or any other regulation which may be given.
- Some routes might not be searched.
- The route to the destination might not be shown if there are new roads, if roads have recently changed, or if certain roads are not listed in the map data. See *Maps* ⇨ 61.

To recalibrate the vehicle's position on the map, park with the vehicle running for two to five minutes, until the vehicle position updates. Make sure the vehicle is parked in a

location that is safe and has a clear view of the sky and away from large obstructions.

If the System Needs Service

If the navigation system needs service and the steps listed here have been followed but there are still problems, see *Problems with Route Guidance* ⇨ 78.

Map Data Updates

The map data in the vehicle is the most up-to-date information available when the vehicle was produced. The map data is updated periodically, provided that the map information has changed.



For questions about the operation of the navigation system or the update process, contact the GM Nav Disc Center toll-free phone number, 1-877-NAV-DISC (1-877-628-3472) or go to the center's website, www.gmnavdisc.com. If updates are needed, call the GM Nav Disc Center or order online.

To order, have the vehicle's Vehicle Identification Number (VIN) available ensure the correct and most up-to-date map data for the vehicle is sent. See "Vehicle Identification Number (VIN)" in the owner manual.

Database Coverage Explanations

Coverage areas vary with respect to the level of map detail available for any given area. Some areas feature greater levels of detail than others. If this happens, it does not mean there is a problem with the system. As the map data is updated, more detail can become available for areas that previously had limited detail. See *Map Data Updates* ⇨ 79.

Voice Recognition

Voice recognition allows for hands-free operation within the navigation, audio, phone, and weather applications. This feature can be started by pressing either the  button on the steering wheel or touching  on the touchscreen display.



However, not all features within these areas are supported by voice commands. Generally, only complex tasks that require multiple manual interactions to complete are supported by voice commands.

For example, tasks that take more than one or two button presses such as selecting a song or artist to play from a media device would be supported by voice commands. Other tasks, like adjusting the volume or seeking up or down are audio features that are easily performed by pressing one or two buttons, and are not supported by voice commands.

Voice recognition can be used when the ignition is on or when Retained Accessory Power (RAP) is active. See “Retained Accessory Power (RAP)” in the owner manual.

Using Voice Recognition

Voice recognition becomes available once the system has been initialized. This begins when the ignition is turned on. Initialization may take a few moments.

1. Press  on the steering wheel control to activate voice recognition, or touch  on the infotainment touchscreen on the center stack.
2. The audio system mutes and the system plays a prompt followed by a beep.
3. Wait until after the beep completes, then clearly speak one of the commands described in this section.

Press  to interrupt any voice recognition system prompt. For example, if the prompt seems

to be taking too long to finish, press  again and the beep should happen right away.

There are two voice prompt modes supported:

- Long verbal prompts: The longer prompts provide more information regarding the supported actions.
- Short prompts: The short prompts provide simple instructions about what can be stated.

If a command is not spoken, the voice recognition system says a help prompt.

Prompts and Screen Displays

While a voice recognition session is active, there will be corresponding buttons on screens displayed. Manual interaction in the voice recognition session is permitted. Interaction during a voice session may be completed entirely using voice commands, or some selections may expedite a session. If a selection is made using a manual control, the dialog will

progress in the same way as if the selection was made through a voice command. Once the system is able to complete the task, or the session is terminated, the voice recognition dialog stops.

An example of this type of manual intervention is touching on an entry of a displayed number list instead of speaking the number associated with the entry desired.

Canceling Voice Recognition

- Touch the Home screen button. Pressing this button will terminate a voice recognition session which was initiated by pressing the button on the radio touchscreen.
- Touch or say “Cancel” or “Exit” to terminate the voice recognition session and display the screen from which voice recognition was initiated.
- Press  on the steering wheel controls to terminate the voice session and display the screen from which voice recognition was initiated.

Helpful Hints for Speaking Commands

Voice recognition can understand commands that are either naturally stated in sentence form, or direct commands that state the application and the task.

Most languages do not support natural language commands in sentence form. For those languages, use direct commands like the examples shown on the display.

For best results:

- Listen for the prompt and wait for the beep before saying a command or reply.
- Say “Help” or look at the screen display for example commands.
- A voice recognition system prompt can be interrupted while it is playing by pressing .

For example, if the prompt seems to be taking too long to finish, to speak the command without waiting for the prompt to complete, press .

- Speak the command naturally, not too fast, not too slow. Use direct commands without a lot of extra words.
- Usually Phone and Audio commands can be spoken in a single command.

For example say, “Call Dave Smith at work,” “Play” followed by the artist or song name, or “Tune” followed by the radio station number.

- Navigation destinations are too complex for a single command. First, say a command that explains the type of destination needed, such as I want directions to an “Address,” “Navigate to an intersection,” “I need to find a Place of Interest or POI,” or “Directions to a Contact.” The system responds by requesting more details. After saying “Place of Interest,” only major chains are available by name. Chains are businesses with at least 20 locations. For

other POIs, say the name of a category like “Restaurants,” “Shopping Malls,” or “Hospitals.”

There is no need to memorize specific command words. Direct commands might be more clearly understood by the system. An example of a direct command would be “Call 555-1212.” Examples of these direct commands are displayed on most of the screens while a voice session is active. If “Phone” or “Phone Commands,” is stated, the system understands that a phone call is requested and will respond with questions until enough details are gathered.

If the phone number has been saved with a name and a place, the direct command should include both, for example “Call Dave Smith at work.”

Using Voice Recognition for List Options

When a list is displayed, a voice prompt will ask to confirm or select an option from that list. A selection

can be made by manually selecting the item, or by speaking the line number for the item to select.

When a screen contains a list, there may be options that are available but not displayed. The list on a voice recognition screen functions the same as a list on other screens. Scrolling or flinging can be used to help display other entries from the list.

Manually scrolling or paging the list on a screen during a voice recognition session suspends the current voice recognition event and plays the prompt “Make your selection from the list using the manual controls or press the Back button to try again.”

If manual selection takes more than 15 seconds, the session terminates and prompts that it has timed out. The screen returns back to the screen where voice recognition was initiated.

The Back Command

Say “Back” or press the BACK button to go to the previous screen.

If in voice recognition, and “Back” is stated all the way through to the initial screen, then “Back” is stated one more time, the voice recognition session will cancel.

Help

Say “Help” on any voice recognition screen and the help prompt for the screen is played. Additionally, a pop-up displays a text version of the help prompt. Depending on how voice recognition was initiated, the Help pop-up will either display on the instrument cluster or the infotainment touchscreen. Touch the Dismiss button to make the pop-up go away.

Pressing  while the help prompt is playing will terminate the prompt and a beep will be heard. Doing this will stop the help prompt so that a voice command can be used.

Voice Recognition for the Radio

Some audio screens have a voice recognition button (🗣️) to launch audio voice recognition. If the voice button is touched in a radio screen, the voice commands for radio and media features are available.

“Switch to AM” : Switch bands to AM and tune to the last AM radio station.

“Switch to FM” : Switch bands to FM and tune to the last FM radio station.

“Switch to XM” : Switch bands to XM and tune to the last XM channel.

“Tune to <AM frequency> AM” : Tune to the radio station whose frequency is identified in the command (like “nine fifty”).

“Tune to <FM frequency> FM” : Tune to the radio station whose frequency is identified in the command (like “one o one point one”).

If equipped, “Tune to <AM frequency> AM HD” : Tune to the HD Radio station whose frequency is identified in the command.

If equipped, “Tune to <FM frequency> FM HD” : Tune to the HD Radio station whose frequency is identified in the command.

If equipped, “Tune to <FM frequency> FM HD <HD channel number>” : Tune to the HD Radio station whose frequency and HD channel is identified in the command.

“Tune to XM <XM channel number>” : Tune to the XM radio station whose channel number is identified in the command.

“Tune to XM <XM channel name>” : Tune to the XM radio station whose channel name is identified in the command.

Voice Recognition for Audio My Media

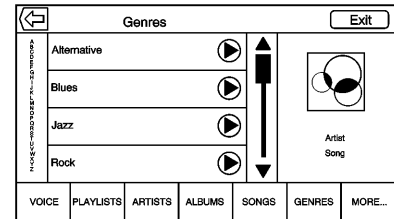

If browsing My Media when the voice button is selected, the voice recognition commands for My Media features are available.

“Play Artist” : Begin a dialog to enter a specific artist name.

“Play Artist <artist name>” : Begin playback of the media selection identified in the command.

“Play Album” : Begin a dialog to enter a specific album name.

“Play Album <album name>” : Begin playback of the identified album name in the command.

“Play Song” : Begin a dialog to enter a specific song name.

“Play Song <song name>” : Begin playback of the identified song name in the command.

“Play Genre” : Begin a dialog to enter a specific genre.

“Play Genre <genre name>” : Begin playback of the media selection identified in the command.

“Play Playlist” : Begin a dialog to enter a specific playlist name.

“Play Playlist <playlist name>” : Begin playback of the identified playlist in the command.

“Play <device name>” : Play music from a specific device identified by name. The device name is the name displayed on the screen when the device is first selected as an audio sourced.

“Play Chapter” : Begin a dialog to enter a specific name.

“Play Chapter <chapter name>” : Begin playback of the media selection identified in the command.

“Play Audiobook” : Begin a dialog to enter a specific name.

“Play Audiobook <audiobook name>” : Begin playback of the media selection identified in the command.

“Play CD Track <track number>” : Begin playback of the CD at the track identified in the command.

“Play Episode” : Begin a dialog to enter a specific name.

“Play Episode <episode name>” : Begin playback of the media selection identified in the command.

“Play Podcast” : Begin a dialog to enter a specific name.

“Play Podcast <podcast name>” : Begin playback of the media selection identified in the command.

“Play Video” : Begin a dialog to enter a specific name.

“Play Video <video name>” : Begin playback of the media selection identified in the command.

“My Media” : Begin a dialog to enter the desired media content.

Handling Large Amounts of Media Content

It is expected that large amounts of media content will be brought into the vehicle. It may be necessary to handle large amounts of media content in a different way than smaller amounts of media. The system may limit the options of voice recognition by not allowing selection of song titles by voice at the highest level if the number of songs exceeds the maximum limit.

Voice command option changes through media content limits are:

- Song files including other individual files of all media types such as audiobook chapters, podcast episodes, and videos.
- Album type folders including types such as albums and audiobooks.

There are no restrictions if the number of song files and albums is less than 4,000. When the number of song files connected to the system is between 4,000 and 8,000,

the content cannot be accessed directly with one command like "Play <song name>."

The restriction is that the command "Play Song" must be spoken first; the system will then ask for the song name. The reply command would be to say the name of the song to play.

Similar limits exist for album content. If there are more than 4,000 albums, but less than 8,000, the content cannot be accessed directly with one command like, "Play <album name>." The command "Play Album" must first be spoken; the system will then ask for the album name. The reply would be to say the name of the album to play.

Once the number of songs has exceeded approximately 8,000, there is no support for accessing the songs directly through voice commands. There will still be access to the media content by using commands for playlists, artists, and genres.

The access commands for playlists, artists, and genres are prohibited after the number of this type of media exceeds 4,000.

The system will provide feedback the first time voice recognition is initiated if it has become apparent that any of these limits are reached during a device initializing process.

Voice Recognition for Navigation

"Navigation" : Begin a dialog to enter specific destination information.

"Navigation Commands" : Begin a dialog to enter specific destination information.

"Destination Address" : Begin a dialog to enter a specific destination address, which includes the entire address consisting of the house number, street name, and city and state.

"Destination Intersection" : Begin a dialog to enter a specific destination intersection.

"Destination Place of Interest" : Begin a dialog to enter a destination Place of Interest category or major brand name (if equipped).

Not all brand names of businesses are available for voice entry. Most major chains, such as chains with more than 20 locations, should be available to search for by name, but the name must be precisely spoken. Nicknames or short names for the businesses will not likely be found. Lesser known businesses might have to be located by category, such as fast food, hotels, or banks.

"Destination Contact" : Begin a dialog to enter a specific destination contact name.

"Cancel Route" : End route guidance.

Voice Recognition for the Phone

"Call <contact name>" : Initiate a call to an entered contact. The command may include location if the contact has location numbers stored.

“Call <contact name> At Home,” “At Work,” “On Mobile,” or “On Other” : Initiate a call to an entered contact and location at home, at work, on mobile device, or on another phone.

“Call <phone number>” : Initiate a call to a standard phone number seven or 10 digits in length, and also 911, 411, or 611.

If the call is being initiated outside of North America, state “Call <phone number>,” then after the system reads back the number, repeat the “Call” command to initiate the call. If the number is not correct, “Delete” will delete the number and allow it to be entered again. If the number is not complete, speak the remaining digits.

“Pair Phone” : Begin the Bluetooth pairing process. Follow instructions on the radio display.

“Switch Phone” : Select a different phone for outgoing calls.

“Voice Keypad” : Begins a dialog to enter special numbers like international numbers. The numbers can be entered in groups of digits with each group of digits being repeated back by the system. If the group of digits is not correct, the command “Delete” will remove the last group of digits and allow them to be re-entered. Once the entire number has been entered, the command “Call” will start dialing the number.

“Voice Mail” : Initiate a call to voice mail numbers.

Voice Pass-Thru

Voice pass-thru allows access to the voice recognition commands on the cell phone, for example, Siri or Voice Command. See the cell

phone manufacturer's user guide to see if the cell phone supports this feature. To activate the phone voice recognition system, press and hold  on the steering wheel for a few seconds.

Voice Recognition for OnStar (If Equipped)

“OnStar” : Begin Onstar Voice Recognition.

Voice Recognition for Weather (If Equipped)

“Weather” : Begin a dialog to enter a weather location.

Phone

Bluetooth (Overview)

The Bluetooth-capable system can interact with many cell phones, allowing:

- Placement and receipt of calls in a hands-free mode.
- Sharing of the cell phone's address book or contact list with the vehicle.

To minimize driver distraction, before driving, and with the vehicle parked:

- Become familiar with the features of the cell phone. Organize the phone book and contact lists clearly and delete duplicate or rarely used entries. If possible, program speed dial or other shortcuts.
- Review the controls and operation of the infotainment system.

- Pair cell phone(s) to the vehicle. The system may not work with all cell phones. See "Pairing" in this section.

Vehicles with a Bluetooth system can use a Bluetooth-capable cell phone with a Hands-Free Profile to make and receive phone calls. The infotainment system and voice recognition are used to control the system. The system can be used while in ON/RUN or ACC/ACCESSORY. The range of the Bluetooth system can be up to 9.1 m (30 ft). Not all phones support all functions and not all phones work with the Bluetooth system. See www.gm.com/bluetooth for more information about compatible phones.

Bluetooth Controls

Use the buttons on the infotainment system and the steering wheel to operate the Bluetooth system.

Steering Wheel Controls

 **(Push to Talk)** : Press to answer incoming calls, confirm system information, and start voice recognition.

 **(End Call)** : Press to end a call, decline a call, or cancel an operation. Press to mute or unmute the infotainment system when not on a call.

Infotainment System Controls

For information about how to navigate the menu system using the infotainment controls, see *Using the System* ⇨ 13.

Phone : Touch this screen button on the Home Page to enter the phone main menu.

Audio System

When using the Bluetooth system, sound comes through the vehicle's front audio system speakers and overrides the audio system. Turn the volume knob during a call to change the volume level. The

adjusted volume level remains in memory for later calls. The system maintains a minimum volume level.

Bluetooth (Infotainment Controls)

For information about how to navigate the menu system using the infotainment controls, see *Using the System* ⇨ 13.

Pairing

A Bluetooth-enabled cell phone must be paired to the Bluetooth system and then connected to the vehicle before it can be used. See the cell phone manufacturer's user guide for Bluetooth functions before pairing the cell phone. If a Bluetooth phone is not connected, calls can be made using OnStar Hands-Free Calling (if equipped). See "OnStar" in the owner manual.

Pairing Information

- A Bluetooth phone with music capability can be paired to the vehicle as a phone and a music player at the same time.

- Up to 10 devices can be paired to the Bluetooth system.
- The pairing process is disabled when the vehicle is moving.
- Pairing only needs to be completed once, unless the pairing information on the cell phone changes or the cell phone is deleted from the system.
- One Bluetooth device can be connected to the Bluetooth system at a time.
- If multiple paired cell phones are within range of the system, the system connects to the paired cell phone in the order that they were last used in the system. To link to a different paired phone, see "Linking to a Different Phone" later in this section.

Pairing a Phone

1. Touch the Phone screen button.
2. Select Phone and select Pair Device.

3. A four-digit Personal Identification Number (PIN) appears on the display. The PIN, if required, may be used in Step 5.
4. Start the pairing process on the cell phone to be paired to the vehicle. See the cell phone manufacturer's user guide for information on this process.
5. Locate "Chevrolet MyLink" on the display. Follow the instructions on the cell phone to enter the PIN provided in Step 3 or confirm the six-digit code shown on the display. After the PIN is successfully entered or the code is confirmed, the system responds with "<Device name> has been successfully paired" when the pairing process is complete.
6. If "Chevrolet MyLink" does not appear, turn the phone off or remove the phone battery and retry.

- If the phone prompts to accept connection or allow phone book download, select always accept and allow. The phone book may not be available if not accepted.
- Repeat Steps 1–7 to pair additional phones.

Listing All Paired and Connected Phones

- Touch the Phone screen button.
- Select Phones.

Disconnecting a Connected Phone

- Touch the Phone screen button.
- Select Phones.
- Touch the **X** next to the phone to disconnect.

Deleting a Paired Phone

Only disconnected phones can be deleted.

- Touch the Phone screen button.
- Select Phones.

- Touch the \ominus next to the phone to delete and follow the on screen prompts.

Linking to a Different Phone

To link to a different phone, the new phone must be in the vehicle and paired to the Bluetooth system.

- Touch the Phone screen button.
- Select Phones.
- Select the new phone to link to from the not connected device list.

Switching to Handset or Handsfree Mode

To switch between handset or handsfree mode, touch the Phone icon on the Home Page to display “Call View.”

- While the active call is hands-free, touch the Handset screen button to switch to the handset mode. The screen button changes to Handsfree

once the Bluetooth device confirms it is operating as handset.

- While the active call is handset, touch the Handsfree screen button to switch to the hands free mode. The screen button changes to Handset once the Bluetooth device confirms it is operating as handsfree.

Making a Call Using Contacts and Recent Calls

Calls can be made through the Bluetooth system using personal cell phone contact information for all phones that support the Phone Book feature. Become familiar with the phone settings and operation. Verify the cell phone supports this feature.

When supported, the Contacts and Recent Calls menus are automatically available.

The Contacts menu accesses the phone book stored in the cell phone.

The Recent Calls menu accesses the recent call list(s) from your cell phone.

To make a call using the Contacts menu:

1. Touch the Phone screen button.
2. Select Contacts.
3. Select the name to call.
4. Select the desired contact number to call.

To make a call using the Recent Calls menu:

1. Touch the Phone screen button.
2. Select Recent.
3. Select the name or number to call.
4. If necessary, select between Missed, Recent, and Sent calls by selecting the View button in the top right corner of the list.

Making a Call Using the Keypad

To make a call by dialing the numbers:

1. Touch the Phone screen button.

2. Select Keypad and enter a phone number.
3. Select Call to start dialing the number.

Accepting or Declining a Call

When an incoming call is received, the infotainment system mutes and a ring tone is heard in the vehicle.

Accepting a Call

There are a few ways to accept a call:

- Press  on the steering wheel controls.
- Touch Answer on the center stack display.

Declining a Call

There are a few ways to decline a call:

- Press  on the steering wheel controls.
- Touch Ignore on the center stack display.

Call Waiting

Call waiting must be supported on the Bluetooth phone and enabled by the wireless service carrier to work.

Accepting a Call

There are a few ways to accept a call-waiting call:

- Press  on the steering wheel controls.
- Touch Switch on the center stack display.

Declining a Call

There are a few ways to decline a call-waiting call:

- Press  on the steering wheel controls.
- Touch Ignore on the center stack display.

Switching Between Calls (Call Waiting Calls Only)

To switch between calls, touch the phone icon on the Home Page to display "Call View." While in Call View, touch the call information of the call on hold to change calls.

Three-Way Calling

Three-way calling must be supported on the Bluetooth phone and enabled by the wireless service carrier to work.

To start a three-way call while in a current call:

1. In the Call View, select Add to add another call.
2. Initiate the second call by selecting from RECENT, CONTACTS, or KEYPAD.
3. When the second call is active, touch Merge to conference the three-way call together.
4. Once all calls are merged, the Merge button becomes an Unmerge button. Touch to unmerge the calls. Some wireless service carriers may not allow a merged call to become unmerged.

Ending a Call

- Press  on the steering wheel controls.

- Touch End on the center stack display to end all existing calls, or touch End next to a call to end only that call.

Some wireless service carriers may not allow a merged call to become unmerged.

Dual Tone Multi-Frequency (DTMF) Tones

The in-vehicle Bluetooth system can send numbers during a call. This is used when calling a menu-driven phone system.

1. Touch the Phone screen button.
2. While in the Call View, touch  to raise the Interaction Selector.
3. Select Keypad and enter the number.

Voice Mail

The default voice mail number is the phone number of the currently connected phone. The voice mail number can be changed in Bluetooth settings.

To dial a voice mail number:

1. Touch the Phone screen button.
2. Select Voice Mail.
3. Select Call.
4. Enter the DTMF tones using the keypad if needed.

Bluetooth (Voice Recognition)

Using Bluetooth Voice Recognition

To use voice recognition, press the  button on the steering wheel. Use the commands below for the various voice features. For additional information, say "Help" while in a voice recognition menu. See *Voice Recognition* ⇨ 80 for help using voice recognition commands.

Making a Call

Calls can be made using the following commands.

Using the “Dial” or “Call” Command

To call a number:

1. Press $\mathbb{1}$. The system responds “Command Please,” followed by a tone.
2. Say “Dial” or “Call” followed by the complete phone number.

Use the “Voice Keypad” command for international numbers or special numbers which include * or #.

Once connected, the person called will be heard through the audio speakers.

To call using a contact from your phone book:

1. Press $\mathbb{1}$. The system responds “Command Please,” followed by a tone.
2. Say “Dial” or “Call” and then say the contact name. For example “Call John at Work.”

Once connected, the person called will be heard through the audio speakers.

Calling 911 Emergency (U.S. and Canada)

1. Press $\mathbb{1}$. The system responds “Command Please,” followed by a tone.
2. Say “Call 911.”

Once connected, the person called will be heard through the audio speakers.

Using the “Switch Phone” Command

1. Press $\mathbb{1}$. The system responds “Command Please,” followed by a tone.
2. After the tone, say “Switch Phone.” The system displays a list of phones to select.

Using the “Voice Keypad” Command

1. Press $\mathbb{1}$. The system responds “Command Please,” followed by a tone.

2. After the tone, say “Voice Keypad.” The system allows entry of special numbers and characters.

Using the “Voice Mail” Command

1. Press $\mathbb{1}$. The system responds “Command Please,” followed by a tone.
2. After the tone, say “Voice Mail.” The system dials the voice mail number of the connected phone.

Clearing the System

Unless information is deleted out of the vehicle Bluetooth system, it will be retained. This includes phone pairing information. For directions on how to delete this information, see “Deleting a Paired Phone.”

Text Messaging

If equipped, the infotainment system may allow text messages to be received and replied to. Received messages can also be read aloud.

Before using the text messaging feature, check to see if the phone is compatible.

To view compatible phones in the U.S., see my.chevrolet.com.

To view compatible phones in Canada, see gmtotalconnect.ca.

Text Menu

Inbox : Touch to display incoming messages. To view a message, touch on the name of the sender.

Touch  to listen to the text message. Press BACK on the faceplate or touch the Back screen button to go back to the previous menu.

Settings : See “Text Settings” later in this section.

Reply : Touch to reply using a predefined text message. See “Text Settings.”

Call : Touch to place a call to the sender of the text message.

Viewing a Text Message

While viewing a text message:

- Touch Reply to reply using a predefined text message.
- Touch Call to place a call to the sender of the text message.

Viewing Sender Information

If equipped, touch the name of the sender to view sender information if this information matches contact information already stored.

Select a Predefined Message :

Touch to select from a set of quick messages. Touch the message to send.

Predefined Messages

These are short text messages that can be used to send so responses will not have to be typed.

The messages can be deleted or a new message can be added.

To add a new message:

1. Touch Text Settings, then press Manage Predefined Messages.

2. While in the predefined messages list view, select Add New Predefined Message and a keyboard displays.
3. Type a new message and touch NEW MSG when done to add the message. Press BACK on the faceplate or touch the Back screen button to go back to the predefined messages list. Touch **X** to delete one character at a time.

Memory Full

This message may display if there is no more room on the phone to store messages.

Text Settings

Text Alerts : When on, this feature will display an alert when a new text message has been received. Touch to turn on or off.

Manage Predefined Messages : Touch to add, change, or delete predefined messages.

Apple CarPlay and Android Auto

If equipped, Android Auto™ and/or Apple CarPlay™ capability may be available through a compatible smartphone. If available, a PROJECTION icon will appear on the Home Page of the infotainment display.

To use Android Auto and/or Apple CarPlay:

1. Download the Android Auto app to your phone from the Google™ Play store. There is no app required for Apple CarPlay.
2. Connect your Android phone or Apple iPhone by using the compatible phone USB cable and plugging into a USB data port. For best performance, use the device's factory-provided USB cable. Aftermarket or third-party cables may not work.

The PROJECTION icon on the Home Page will change to Android Auto or Apple CarPlay depending on the phone. Android Auto and/or Apple CarPlay may automatically launch upon USB connection. If not, press the ANDROID AUTO and/or APPLE CARPLAY icon on the Home Page to launch.

For further information on how to set up Android Auto and Apple CarPlay in the vehicle, see my.chevrolet.com or see “Customer Assistance” in the owner manual.

Android Auto is provided by Google and is subject to Google's terms and privacy policy. CarPlay is provided by Apple and is subject to Apple's terms and privacy policy. For Android Auto support see <https://support.google.com/androidauto> or Apple CarPlay support at <https://www.apple.com/ios/carplay/> for more information. Apple or Google may change or suspend availability at any time.

Android Auto is a trademark of Google Inc.; Apple CarPlay is a trademark of Apple Inc.

Settings

The Settings menu allows adjustment of different vehicle and radio features. The menu may contain the following:

Time and Date

Touch + or – to increase or decrease hours, minutes, and AM or PM. Press 12Hr or 24Hr for 12 or 24 hour clock. Press + or – to increase or decrease month, day, or year. See “Clock” in the owner manual.

Language

This will set the display language in the radio, instrument panel, and voice recognition. Press Language and select the appropriate language. Press  Back to go back to the previous menu.

Valet Mode (If Equipped)

This will lock the infotainment system and steering wheel controls. It may also limit top speed, power, and access to vehicle storage locations (if equipped).

To enable valet mode:

1. Enter a four-digit code on the keypad.
2. Touch Enter to go to the confirmation screen.
3. Re-enter the four-digit code.



Touch LOCK or UNLOCK to lock or unlock the system. Touch  Back to go back to the previous menu.

Radio

Touch to display the Radio Menu and the following may display:

- **Manage Favorites:** Touch to highlight a favorite to edit. Touch Rename to rename the favorite or Delete to delete it. Touch and hold the station to drag it to a new location. Touch Done to go back to the previous menu.
- **Number of Favorites Shown:** Touch to set the number of favorites to display. Select Auto, 5, 10, 15, 20, 25, 30, 35, 40, 45, 50, 55, or 60. Auto will adjust the

number of favorite locations that can be seen. Touch  Back to go back to the previous menu.

- **Auto Volume (If Equipped):** This feature adjusts the volume based on the vehicle speed. See *AM-FM Radio*  17.
- **Bose AudioPilot noise compensation technology (If Equipped):** This feature adjusts the volume based on the noise in the vehicle and speed. See *AM-FM Radio*  17.
- **Maximum Startup Volume:** This feature sets the maximum startup volume. If the vehicle is started and the volume is greater than this level, the volume is adjusted to this level. To set the maximum startup volume, touch + or – to increase or decrease. Touch  Back to go back to the previous menu.
- **Audio Cue Volume (If Equipped):** This feature adjusts the startup and shutdown sounds. To adjust the volume, touch + or – to increase or decrease. This

feature can be turned on or off.
Touch  Back to go back to the previous menu.

Vehicle Settings

See “Vehicle Personalization” in the owner manual.

Bluetooth

From the Bluetooth screen button, the following may be displayed:

- Pair New Device: Touch to add a new device.
- Device Management: Touch to connect to a different phone source, disconnect a phone, or delete a phone.
- Ringtones: Touch to change the ring tone for the specific phone. The phone does not need to be connected to change the ring tone.
- Voice Mail Numbers: This feature displays the voice mail number for all connected phones. The voice mail number may be changed by touching the EDIT button, typing in the new

number, and touching SAVE.
Touch  Back to go back to the previous menu.

- Text Message Alerts: This feature will turn text message alerts on or off. Touch Text Message Alerts and then select OFF or ON. Touch  Back to go back to the previous menu. See *Text Messaging* ⇨ 92.

Voice



From the Voice screen button, the following may be displayed:

- Confidence Threshold: Select Confirm More for a system response to a command. Select Confirm Less for the system to proceed with the command without responding.
- Prompt Length: Select Short for brief, direct feedback or Long for more information feedback.
Touch  Back to go to the previous menu.

- Audio Feedback Speed: Touch Slow, Medium, or Fast for feedback speed. Touch  Back to go back to the previous menu.

Display

From the Display screen button, the following may be displayed:

- Mode: Touch Auto, Day, or Night to adjust the display.
Touch  Back to go to the previous menu.
- Calibrate Touchscreen: Touch to calibrate the touchscreen and follow the prompts.
Touch  Back to go back to the previous menu.
- Turn Display Off: Touch to turn the display off. Touch anywhere on the display area or any faceplate button again to turn the display on.

Rear Camera

Touch to display the Rear Camera menu. See “Driver Assistance Systems” in the owner manual.

Return to Factory Settings

Touching Continue restores all factory settings.

Select Return to Factory Settings and the following list may display:

- **Restore Vehicle Settings:** Restores factory vehicle personalization settings. Touch Restore Vehicle Settings. Touch Cancel or Continue. If continue is touched, a confirmation pop-up will appear indicating the vehicle settings have been restored.
- **Clear All Private Data:** Clears all private information such as phone history or recent destinations. Touch Clear All Private Data. Touch Cancel or Continue. If continue is touched, a confirmation pop-up will appear indicating all private data has been cleared from the system.
- **Restore Radio Settings:** Restores factory radio settings. Touch Restore Radio Settings. Touch Cancel or Continue.

If continue is touched, a confirmation pop-up will appear indicating the radio settings have been restored.

Press ◀ BACK on the faceplate or touch the Back screen button to go back to the main settings menu.

English and Metric Unit Conversion

To change the display units between English and metric units, see “Instrument Cluster” in the owner manual.

Trademarks and License Agreements

FCC Information

See "Radio Frequency Statement" in the owner manual.

Made for



iPod



iPhone

"Made for iPod," and "Made for iPhone," mean that an electronic accessory has been designed to connect specifically to iPod or iPhone and has been certified by the developer to meet Apple performance standards. Apple is not responsible for the operation of this device or its compliance with safety and regulatory standards. Please note that the use of this accessory with iPod or iPhone may affect wireless performance. iPhone®, iPod®, iPod classic®, iPod nano®,

iPod shuffle®, and iPod touch® are trademarks of Apple Inc., registered in the U.S. and other countries.



Fees and Taxes: Subscription fee, taxes, one time activation fee, and other fees may apply. Subscription fee is consumer only. All fees and programming subject to change. Subscriptions subject to Customer Agreement available at www.siriusxm.com. SiriusXM® service only available in the 48 contiguous United States and Canada.

In Canada: Some deterioration of service may occur in extreme northern latitudes. This is beyond the control of SiriusXM® Satellite Radio.

Explicit Language Notice: Channels with frequent explicit language are indicated with an "XL" preceding the

channel name. Channel blocking is available for SiriusXM Satellite Radio receivers by notifying SiriusXM:

- USA Customers — See www.siriusxm.com or call 1-866-635-2349.
- Canadian Customers — See www.xmradio.ca or call 1-877-209-0079.

It is prohibited to copy, decompile, disassemble, reverse engineer, hack, manipulate, or otherwise make available any technology or software incorporated in receivers compatible with the SiriusXM® Satellite Radio System or that support the SiriusXM website, the Online Service or any of its content. Furthermore, the AMBER voice compression software included in this product is protected by intellectual property rights including patent rights, copyrights, and trade secrets of Digital Voice Systems, Inc.

General Requirements:

1. A License Agreement from SiriusXM[®] is required for any product that incorporates SiriusXM Technology and/or for use of any of the SiriusXM marks to be manufactured, distributed, or marketed in the SiriusXM Service Area.
2. For products to be distributed, marketed, and/or sold in Canada, a separate agreement is required with Canadian Satellite Radio Inc. (operating as SiriusXM Canada).

Bose[®]

Bose, AudioPilot, Centerpoint, and Studio Surround are registered trademarks of Bose Corporation in the U.S. and other countries.

HD Radio Technology (If Equipped)



HD Radio Technology manufactured under license from iBiquity Digital Corporation. U.S. and Foreign patents. HD Radio™ and the HD, HD Radio, and “Arc” logos are proprietary trademarks of iBiquity Digital Corp.

DTS

Manufactured under license under U.S. Patent Nos: 5,956,674; 5,974,380; 6,487,535 & other U.S. and worldwide patents issued & pending.

DTS, the Symbol, & DTS and the Symbol together are registered trademarks & DTS 2.0 Channel is a trademark of DTS, Inc. Product includes software. ©DTS, Inc. All Rights Reserved.

Dolby

Manufactured under license from Dolby Laboratories. Dolby and the double-D symbol are trademarks of Dolby Laboratories.



DivX Certified[®] to play DivX[®] video, including premium content.

This DivX Certified[®] device has passed rigorous testing to ensure it plays DivX[®] video.

To play purchased DivX movies, first register your device at vod.divx.com. Find your registration code in the DivX VOD section of your device setup menu.

Covered by one or more of the following U.S. patents: 7,295,673; 7,460,668; 7,515,710; 7,519,274.

DivX[®], DivX Certified[®] and associated logos are trademarks of DivX, LLC and are used under license.

BDA

Blu-ray Disc, Blu-ray, Blu-ray 3D, BD-Live, BONUSVIEW, BDXL, AVCREC, and the logos are trademarks of the Blu-ray Disc Association.

AVCHD

AVCHD and the AVCHD logo are trademarks of Panasonic Corporation and Sony Corporation.

AVCREC

Blu-ray Disc, Blu-ray, Blu-ray 3D, BD-Live, BONUSVIEW, BDXL, AVCREC, and the logos are trademarks of the Blu-ray Disc Association.

Java

Java is a registered trademark of Oracle and/or its affiliates.

Cinavia

Cinavia Notice: This product uses Cinavia technology to limit the use of unauthorized copies of some commercially-produced film and videos and their soundtracks. When a prohibited use of an unauthorized copy is detected, a message will be displayed or copying will be interrupted.

More information about Cinavia technology is provided at the Cinavia Online Consumer Information Center at <http://www.cinavia.com>. To request additional information about Cinavia by mail, send a postcard with your mailing address to: Cinavia Consumer Information Center, P.O. Box 86851, San Diego, CA, 92138, USA.

This product incorporates proprietary technology under license from Verance Corporation and is protected by U.S. Patent 7,369,677 and other U.S. and worldwide patents issued and pending as well as copyright and trade secret protection for certain

aspects of such technology. Cinavia is a trademark of Verance Corporation. Copyright 2004-2015 Verance Corporation. All rights reserved by Verance. Reverse engineering or disassembly is prohibited.

RMVB



Portions of this software are included under license from RealNetworks, Inc. Copyright 1995-2015, RealNetworks, Inc. All rights reserved

Bluetooth[®]

The Bluetooth word mark and logos are owned by the Bluetooth[®] SIG, Inc. and any use of such marks by General Motors is under license. Other trademarks and trade names are those of their respective owners.

Schedule I: Gracenote EULA

Music recognition technology and related data are provided by Gracenote®. Gracenote is the industry standard in music recognition technology and related content delivery. For more information visit www.gracenote.com.

Music-related data from Gracenote, Inc., copyright © 2000 to present Gracenote. Gracenote Software, copyright © 2000 to present Gracenote. One or more patents owned by Gracenote may apply to this product and service. See the Gracenote website for a non-exhaustive list of applicable Gracenote patents. Gracenote, CDDB, MusicID, MediaVOCS, the Gracenote logo and logotype, and the "Powered by Gracenote" logo

are either registered trademarks or trademarks of Gracenote in the United States and/or other countries.

Gracenote Terms of Use

This application or device contains software from Gracenote, Inc. of Emeryville, California ("Gracenote"). The software from Gracenote (the "Gracenote Software") enables this application to do disc or file identification and obtain music-related information, including name, artist, track, and title information ("Gracenote Data") from online servers or embedded databases (collectively, "Gracenote Servers") and to perform other functions. You may use Gracenote Data only by means of the intended End-User functions of this application or device.

This application or device may contain content belonging to Gracenote's providers. If so, all of the restrictions set forth herein with respect to Gracenote Data shall also apply to such content and such content providers shall be entitled to

all of the benefits and protections set forth herein that are available to Gracenote.

You agree that you will use Gracenote Data, the Gracenote Software, and Gracenote Servers for your own personal non-commercial use only. You agree not to assign, copy, transfer or transmit the Gracenote Software or any Gracenote Data to any third party. **YOU AGREE NOT TO USE OR EXPLOIT GRACENOTE DATA, THE GRACENOTE SOFTWARE, OR GRACENOTE SERVERS, EXCEPT AS EXPRESSLY PERMITTED HEREIN.**

You agree that your non-exclusive license to use the Gracenote Data, the Gracenote Software, and Gracenote Servers will terminate if you violate these restrictions. If your license terminates, you agree to cease any and all use of the Gracenote Data, the Gracenote Software, and Gracenote Servers. Gracenote reserves all rights in Gracenote Data, the Gracenote Software, and the Gracenote Servers, including all ownership

rights. Under no circumstances will Gracenote become liable for any payment to you for any information that you provide. You agree that Gracenote may enforce its rights under this Agreement against you directly in its own name.

The Gracenote service uses a unique identifier to track queries for statistical purposes. The purpose of a randomly assigned numeric identifier is to allow the Gracenote service to count queries without knowing anything about who you are. For more information, see the web page for the Gracenote Privacy Policy for the Gracenote service.

The Gracenote Software and each item of Gracenote Data are licensed to you "AS IS." Gracenote makes no representations or warranties, express or implied, regarding the accuracy of any Gracenote Data. Gracenote reserves the right to delete data from the Gracenote Servers or to change data categories for any cause that Gracenote deems sufficient. No warranty is made that the Gracenote Software or Gracenote Servers are

error-free or that functioning of Gracenote Software or Gracenote Servers will be uninterrupted. Gracenote is not obligated to provide you with new enhanced or additional data types or categories that Gracenote may provide in the future and is free to discontinue its services at any time.

GRACENOTE DISCLAIMS ALL WARRANTIES EXPRESS OR IMPLIED, INCLUDING, BUT NOT LIMITED TO, IMPLIED WARRANTIES OF MERCHANTABILITY, FITNESS FOR A PARTICULAR PURPOSE, TITLE, AND NON-INFRINGEMENT. GRACENOTE DOES NOT WARRANT THE RESULTS THAT WILL BE OBTAINED BY YOUR USE OF THE GRACENOTE SOFTWARE OR ANY GRACENOTE SERVER. IN NO CASE WILL GRACENOTE BE LIABLE FOR ANY CONSEQUENTIAL OR INCIDENTAL DAMAGES OR FOR ANY LOST PROFITS OR LOST REVENUES.

© 2015. Gracenote, Inc. All Rights Reserved.

MPEG4-AVC (H.264)

THIS PRODUCT IS LICENSED UNDER THE AVC PATENT PORTFOLIO LICENSE FOR THE PERSONAL AND NON-COMMERCIAL USE OF A CONSUMER TO (i) ENCODE VIDEO IN COMPLIANCE WITH THE AVC STANDARD ("AVC VIDEO") AND/OR (ii) DECODE AVC VIDEO THAT WAS ENCODED BY A CONSUMER ENGAGED IN A PERSONAL AND NON-COMMERCIAL ACTIVITY AND/OR WAS OBTAINED FROM A VIDEO PROVIDER LICENSED TO PROVIDE AVC VIDEO. NO LICENSE IS GRANTED OR SHALL BE IMPLIED FOR ANY OTHER USE. ADDITIONAL INFORMATION MAY BE OBTAINED FROM MPEG LA, LLC. SEE [HTTP://WWW.MPEGLA.COM](http://www.mpegla.com).

VC-1

THIS PRODUCT IS LICENSED UNDER THE VC-1 PATENT PORTFOLIO LICENSE FOR THE PERSONAL AND NON-COMMERCIAL USE OF A CONSUMER TO (i) ENCODE VIDEO IN COMPLIANCE WITH THE VC-1 STANDARD (“VC-1 VIDEO”) AND/OR (ii) DECODE VC-1 VIDEO THAT WAS ENCODED BY A CONSUMER ENGAGED IN A PERSONAL AND NON-COMMERCIAL ACTIVITY AND/OR WAS OBTAINED FROM A VIDEO PROVIDER LICENSED TO PROVIDE VC-1 VIDEO. NO LICENSE IS GRANTED OR SHALL BE IMPLIED FOR ANY OTHER USE. ADDITIONAL INFORMATION MAY BE OBTAINED FROM MPEG LA, LLC. SEE [HTTP://WWW.MPEGLA.COM](http://www.mpegla.com).

MPEG4–Visual

USE OF THIS PRODUCT IN ANY MANNER THAT COMPLIES WITH THE MPEG-4 VISUAL STANDARD IS PROHIBITED, EXCEPT FOR

USE BY A CONSUMER ENGAGING IN PERSONAL AND NON-COMMERCIAL ACTIVITIES.

MP3

MPEG Layer-3 audio coding technology licensed from Fraunhofer IIS and Thomson.

WMA

This product is protected by certain intellectual property rights of Microsoft. Use or distribution of such technology outside of this product is prohibited without a license from Microsoft.

For more information on the Software, including any open source software license terms (and available source code) as well as copyright attributions applicable to the Runtime Configuration indicated above, please contact the Manufacturer or contact QSSC at 175 Terence Matthews Crescent, Kanata, Ontario, Canada K2M 1W8 (licensing@qnx.com).

Map End User License Agreement

END USER TERMS

The Map Data Disc (“Data”) is provided for your personal, internal use only and not for resale. It is protected by copyright, and is subject to the following terms (this “End User License Agreement”) and conditions which are agreed to by you, on the one hand, and HERE North America, LLC (“HERE”) and its licensors (including their licensors and suppliers) on the other hand.

The Data for areas of Canada includes information taken with permission from Canadian authorities, including: © Her Majesty the Queen in Right of Canada, © Queen’s Printer for Ontario, © Canada Post Corporation, GeoBase®.

HERE holds a nonexclusive license from the United States Postal Service® to publish and sell ZIP+4® information.

© United States Postal Service® 2015. Prices are not established, controlled, or approved by the United States Postal Service®. The following trademarks and registrations are owned by the USPS: United States Postal Service, USPS, and ZIP+4.

TERMS AND CONDITIONS

Personal Use Only: You agree to use this Data for the solely personal, noncommercial purposes for which you were licensed, and not for service bureau, timesharing or other similar purposes. Except as otherwise set forth herein, you agree not to otherwise reproduce, copy, modify, decompile, disassemble or reverse engineer any portion of this Data, and may not transfer or distribute it in any form, for any purpose, except to the extent permitted by mandatory laws. You may transfer the Data and all accompanying materials on a permanent basis if you retain no copies and the recipient agrees to the terms of this End User License Agreement. Multi-disc sets may only

be transferred or sold as a complete set as provided to you and not as a subset thereof.

Restrictions

Except where you have been specifically licensed to do so by HERE and without limiting the preceding paragraph, you may not (a) use this Data with any products, systems, or applications installed or otherwise connected to or in communication with vehicles capable of vehicle navigation, positioning, dispatch, real time route guidance, fleet management or similar applications; or (b) with, or in communication with, including without limitation, cellular phones, palmtop and handheld computers, pagers, and personal digital assistants or PDAs.

Warning

This Data may contain inaccurate or incomplete information due to the passage of time, changing circumstances, sources used, and the nature of collecting

comprehensive geographic data, any of which may lead to incorrect results.

No Warranty

This Data is provided to you “as is,” and you agree to use it at your own risk. HERE and its licensors (and their licensors and suppliers) make no guarantees, representations, or warranties of any kind, express or implied, arising by law or otherwise, including but not limited to, content, quality, accuracy, completeness, effectiveness, reliability, fitness for a particular purpose, usefulness, use or results to be obtained from this Data, or that the Data or server will be uninterrupted or error free.

Disclaimer of Warranty

THE DATABASE IS PROVIDED ON AN “AS IS” AND “WITH ALL FAULTS BASIS” AND BOSCH (AND THEIR LICENSORS AND SUPPLIERS) EXPRESSLY DISCLAIM ALL OTHER WARRANTIES, EXPRESS OR IMPLIED, INCLUDING BUT NOT LIMITED TO, THE IMPLIED WARRANTIES OF

NON-INFRINGEMENT, MERCHANTABILITY, SATISFACTORY QUALITY, ACCURACY, TITLE AND FITNESS FOR A PARTICULAR PURPOSE. NO ORAL OR WRITTEN ADVICE OR INFORMATION PROVIDED BY BOSCH (OR ANY OF THEIR LICENSORS, AGENTS, EMPLOYEES, OR THIRD PARTY PROVIDERS) SHALL CREATE A WARRANTY, AND YOU ARE NOT ENTITLED TO RELY ON ANY SUCH ADVICE OR INFORMATION. THIS DISCLAIMER OF WARRANTIES IS AN ESSENTIAL CONDITION OF THIS AGREEMENT.

Disclaimer of Liability

HERE AND ITS LICENSORS (INCLUDING THEIR LICENSORS AND SUPPLIERS) SHALL NOT BE LIABLE TO YOU IN RESPECT OF ANY CLAIM, DEMAND OR ACTION, IRRESPECTIVE OF THE NATURE OF THE CAUSE OF THE CLAIM, DEMAND OR ACTION ALLEGING ANY LOSS, INJURY OR DAMAGES, DIRECT OR INDIRECT, WHICH MAY RESULT

FROM THE USE OR POSSESSION OF THIS DATA; OR FOR ANY LOSS OF PROFIT, REVENUE, CONTRACTS OR SAVINGS, OR ANY OTHER DIRECT, INDIRECT, INCIDENTAL, SPECIAL OR CONSEQUENTIAL DAMAGES ARISING OUT OF YOUR USE OF OR INABILITY TO USE THIS DATA, ANY DEFECT IN THIS DATA, OR THE BREACH OF THESE TERMS OR CONDITIONS, WHETHER IN AN ACTION IN CONTRACT OR TORT OR BASED ON A WARRANTY, EVEN IF HERE OR ITS LICENSORS HAVE BEEN ADVISED OF THE POSSIBILITY OF SUCH DAMAGES. Some States, Territories, and Countries do not allow certain liability exclusions or damages limitations, so to that extent the above may not apply to you.

Export Control

You agree not to export from anywhere any part of the Data provided to you or any direct product thereof except in compliance with, and with all licenses and approvals required

under, applicable export laws, rules and regulations. Entire Agreement: These terms and conditions constitute the entire agreement between HERE (and its licensors, including their licensors and suppliers) and you pertaining to the subject matter hereof, and supersedes in their entirety any and all written or oral agreements previously existing between us with respect to such subject matter.

Governing Law

The above terms and conditions shall be governed by the laws of the State of Illinois, without giving effect to (i) its conflict of laws provisions, or (ii) the United Nations Convention for Contracts for the International Sale of Goods, which is explicitly excluded. You agree to submit to the jurisdiction of the State of Illinois for any and all disputes, claims, and actions arising from or in connection with the Data provided to you hereunder.

Government End Users

If the Data is being acquired by or on behalf of the United States government or any other entity seeking or applying rights similar to those customarily claimed by the United States government, this Data is a “commercial item” as that term is defined at 48 C.F.R. (“FAR”) 2.101, is licensed in accordance with this End User License Agreement, and each copy of Data delivered or otherwise furnished shall be marked and embedded as appropriate with the following “Notice of Use,” and be treated in accordance with such Notice:

The logo for HERE, consisting of the word "here" in a bold, lowercase, sans-serif font, tilted at an angle.

Maps for Life

NOTICE OF USE

CONTRACTOR (MANUFACTURER/
SUPPLIER)

NAME:

HERE North America, LLC

CONTRACTOR (MANUFACTURER/
SUPPLIER)

ADDRESS:

**425 West Randolph Street,
Chicago, IL 60606.**

This Data is a commercial item as defined in FAR 2.101 and is subject to the End User License Agreement under which this Data was provided.

© 2015 HERE North America, LLC.
All rights reserved.

If the Contracting Officer, federal government agency, or any federal official refuses to use the legend provided herein, the Contracting Officer, federal government agency, or any federal official must notify HERE North America, LLC prior to seeking additional or alternative rights in the Data.

PANDORA

PANDORA, the PANDORA logo, and the Pandora trade dress are trademarks or registered trademarks of Pandora Media, Inc. Used with permission.

Unicode

Copyright © 1991-2015 Unicode, Inc. All rights reserved. Distributed under the Terms of Use in <http://www.unicode.org/copyright.html>.

Free Type Project

Portions of this software are copyright © 2015 The FreeType Project (<http://www.freetype.org>). All rights reserved.

Open Source SW

The open source code used in this device can be downloaded at the webpage shown in the information at the center stack display. Further information concerning the OSS licenses is shown in the center stack display.

QNX

Portions of this software are copyright © 2008-2015, QNX Software Systems. All rights reserved.

Part C – EULA

Copyright 2015, Software Systems GmbH & Co. KG. All Rights Reserved.

The product you have purchased ("Product") contains Software (Runtime Configuration No. 505962; "Software") which is distributed by or on behalf of the Product manufacturer "Manufacturer" under license from Software Systems Co. ("QSSC"). You may only use the Software in the Product and in compliance with the license terms below.

Subject to the terms and conditions of this License, QSSC hereby grants you a limited, non-exclusive, non-transferable license to use the Software in the Product for the purpose intended by the Manufacturer. If permitted by the Manufacturer, or by applicable law,

you may make one backup copy of the Software as part of the Product software. QSSC and its licensors reserve all license+C31 rights not expressly granted herein, and retain all right, title and interest in and to all copies of the Software, including all intellectual property rights therein. Unless required by applicable law you may not reproduce, distribute or transfer, or de-compile, disassemble or otherwise attempt to unbundle, reverse engineer, modify or create derivative works of, the Software. You agree: (1) not to remove, cover or alter any proprietary notices, labels or marks in or on the Software, and to ensure that all copies bear any notice contained on the original; and (2) not to export the Product or the Software in contravention of applicable export control laws.

EXCEPT TO THE EXTENT OTHERWISE REQUIRED BY APPLICABLE LAW, QSSC AND ITS LICENSORS PROVIDE THE SOFTWARE ON AN "AS IS" BASIS, WITHOUT WARRANTIES OR

CONDITIONS OF ANY KIND, EITHER EXPRESS OR IMPLIED INCLUDING, WITHOUT LIMITATION, ANY WARRANTIES OR CONDITIONS OF TITLE, NON-INFRINGEMENT, MERCHANTABILITY OR FITNESS FOR A PARTICULAR PURPOSE. ANY WARRANTIES OR OTHER PROVISIONS OFFERED BY THE MANUFACTURER OR ITS DISTRIBUTOR(S) THAT DIFFER FROM THIS LICENSE ARE OFFERED BY THE MANUFACTURER OR ITS DISTRIBUTOR(S) ALONE AND NOT BY QSSC, ITS AFFILIATES OR THEIR LICENSORS. YOU ASSUME ANY RISKS ASSOCIATED WITH YOUR USE OF THE SOFTWARE UNDER THIS LICENSE.

EXCEPT TO THE EXTENT OTHERWISE REQUIRED BY APPLICABLE LAW (SUCH AS IN THE CASE OF DELIBERATE OR GROSSLY NEGLIGENT ACTS), IN NO EVENT SHALL QSSC, ITS AFFILIATES OR THEIR LICENSORS BE LIABLE TO YOU

UNDER ANY LEGAL THEORY, WHETHER IN TORT (INCLUDING NEGLIGENCE), CONTRACT OR OTHERWISE, FOR DAMAGES, INCLUDING ANY DIRECT, INDIRECT, SPECIAL, INCIDENTAL, OR CONSEQUENTIAL DAMAGES OF ANY CHARACTER ARISING AS A RESULT OF THIS LICENSE OR OUT OF THE USE OR INABILITY TO USE THE PRODUCT (INCLUDING BUT NOT LIMITED TO DAMAGES FOR LOSS OF GOODWILL, WORK STOPPAGE, PRODUCT FAILURE OR MALFUNCTION, OR ANY AND ALL OTHER COMMERCIAL DAMAGES OR LOSSES), EVEN IF QSSC, ITS AFFILIATES OR THEIR LICENSORS HAVE BEEN ADVISED OF THE POSSIBILITY OF SUCH DAMAGES.

WMA

This product is protected by certain intellectual property rights of Microsoft. Use or distribution of such technology outside of this product is prohibited without a license from Microsoft.

For more information on the Software, including any open source software license terms (and available source code) as well as copyright attributions applicable to the Runtime Configuration indicated above, please contact the Manufacturer or contact QSSC at 175 Terence Matthews Crescent, Kanata, Ontario, Canada K2M 1W8 (licensing@qnx.com).

Linotype

Helvetica is a trademark of Linotype Corp. registered in the U.S. Patent and Trademark Office and may be registered in certain other jurisdictions in the name of Linotype Corp. or its licensee Linotype GmbH.

Usage in text form of each of the Licensed Trademarks is:

The trademark attribution requirements for the Licensed Trademarks may be viewed at <http://www.linotype.com/2061-19414/trademarks.html>.

END USER NOTICE

The marks of companies displayed by this product to indicate business locations are the marks of their respective owners. The use of such marks in this product does not imply any sponsorship, approval, or endorsement by such companies of this product.

Index

A		C	
Accepting or Declining a Call	90	Call Waiting	90
Agreements		Canceling Voice Recognition	81
Trademarks and License	98	Card Reader	
AM	22	SD	32
AM-FM Radio	17	CD Player	27
Antenna		Cell Phone Usage	22
Fixed Mast	22	Cleaning High Gloss Surfaces and Vehicle Information and Radio Displays	15
Multi-band	22	Clearing the System	92
Apple CarPlay and		Controls	
Android Auto	94	Steering Wheel	9, 11–13
Applications Tray	14	Coverage Explanations	79
Audio	13	D	
Bluetooth	33	Database Coverage	
Audio Output	50	Explanations	79
Audio Players		Destination	62
CD	27	Detailed Areas	61
Audio System	87	Display	76, 96
Auxiliary Inputs	49	Dual Tone Multi-Frequency (DTMF) Tones	91
Auxiliary Jack	32	E	
B		Ending a Call	91
Bluetooth	96	English and Metric Unit	
Overview	87, 88, 91	Conversion	97
Bluetooth Audio	33	Error Messages	28
Bluetooth Controls	87		

F

Finding a Station	18
Fixed Mast Antenna	22
FM	22

G

Global Positioning System (GPS)	77
Guidance Problems with the Route	78

H

HD Radio Technology	20
Headphones	48
Helpful Hints for Speaking Commands	81
Home Page Features	13

I

If the System Needs Service	79
Infotainment Gestures	14
Infotainment System	3
Infotainment System Settings	17
Internet Radio Pandora	23
Introduction	2

J

Jack Auxiliary	32
----------------------	----

L

Language	95
Launching Pandora	23
Loading and Ejecting Discs	27
Low Fuel Alert	77

M

Making a Call	92
Making a Call Using Contacts and Recent Calls	89
Making a Call Using the Keypad	90
Map Adjustments	60
Map Data Updates	79
Map End User License Agreement	103
Maps	61
Menus and Features	37
Messaging Text	92
Mixed-Audio Favorites	19
Multi-band Antenna	22

N

NAV/ OnStar Nav (Navigation, If Equipped)	14
Navigation Destination	62
Using the System	54
Navigation Symbols	61

O

OnStar (If Equipped)	14
OnStar System	35
OnStar [®] System	75
OnStar [®] with 4G LTE	35
Overview	2

P

Pairing	88
Pandora (If Equipped)	14
Pandora Internet Radio	23
Pandora Troubleshooting	25
Phone Apple CarPlay and Android Auto	94
Bluetooth	87, 88, 91
Playing an Audio CD	27
Playing an MP3 CD	29
Playing from a USB	30
Playing the Radio	17

-
- Port
 - USB.....29
 - Positioning
 - Vehicle.....77
 - Problems with Route
 - Guidance 78
 - R**
 - Radio 95
 - HD Technology.....20
 - Radio Reception 22
 - Radios
 - AM-FM Radio17
 - Satellite21
 - Rear Camera 96
 - Rear Seat Entertainment
 - System 36
 - Recognition
 - Voice.....80
 - Remote Control 50
 - Return to Factory Settings 97
 - RSE Controls Available from
 - the Front Screen 45
 - S**
 - Satellite Radio 21
 - Schedule I: Gracenote EULA ... 101
 - Scroll Features 60
 - SD Card Reader 32
 - Servicing System 79
 - Settings 76, 95, 14
 - SiriusXM Menu 21
 - SiriusXM NavTraffic (If
 - Equipped) 73
 - SiriusXM Travel Link Fuel
 - Pricing 74
 - SiriusXM Travel Link Movie
 - Listings 74
 - SiriusXM Travel Link Weather
 - (If Equipped) 70
 - SiriusXM® Satellite Radio
 - Service 22
 - SiriusXM® Satellite Radio
 - Service (If Equipped) 21
 - Software Updates 16
 - Sources 37
 - Steering Wheel
 - Controls 9, 11–13
 - Storing Media Favorites 28
 - Storing Radio Station Presets ... 19
 - Switching to Handset or
 - Handsfree Mode 89
 - Symbols
 - Navigation.....61
 - System
 - Global Positioning.....77
 - OnStar®.....75
 - Rear Seat Entertainment.....36
 - System Operation 36
 - T**
 - Text Menu 93
 - Text Messaging 92
 - Text Settings 93
 - Three-Way Calling 91
 - Time and Date 95
 - Timeshifting (If Equipped)..... 19
 - Touchscreen Buttons 13
 - Trademarks and License
 - Agreements 98
 - Turn List 68
 - U**
 - Updates
 - Map Data79
 - Software16
 - USB Port 29
 - Using Bluetooth Voice
 - Recognition 91
 - Using the Navigation System ... 54
 - Using the System 13
 - Using Voice Recognition 80

Using Voice Recognition for
List Options 82

V

Valet Mode (If Equipped) 95
Vehicle Positioning 77
Vehicle Settings 96
Video (If Equipped) 14
Video Display Error Messages ... 53
Video Distortion 53
Viewing a Text Message 93
Viewing Sender Information 93
Voice 76, 96
Voice Mail 91
Voice Pass-Thru 86
Voice Recognition 80
Voice Recognition for Audio
My Media 83
Voice Recognition for
Navigation 85
Voice Recognition for OnStar
(If Equipped) 86
Voice Recognition for the
Phone 85
Voice Recognition for the
Radio 83
Voice Recognition for Weather
(If Equipped) 86

W

Weather (If Equipped) 14
Website Information 16